



 **MUGGIOLI**
Giardinaggio

LISTINO PREZZI 2019/12

ATTREZZA LA TUA PASSIONE

MUGGIOLI GIARDINAGGIO

ATTREZZA LA TUA PASSIONE

Da oltre trent'anni proponiamo con passione tecnologie all'avanguardia e strumenti innovativi per la **Cura del Verde**.

Nel campo dell'irrigazione, del giardinaggio e delle attrezzature scegliamo e testiamo prodotti di qualità e marchi di prestigio per soddisfare le esigenze di un mercato in continua evoluzione.

Questo catalogo/listino in particolare è dedicato all'**Irrigazione**. Con oltre duemila articoli ed un servizio di progettazione puntuale ci proponiamo, con esperienza, nei settori dell'irrigazione residenziale e agricola, nel vivaismo e nell'orticoltura riuscendo a soddisfare le richieste più complesse ma anche quelle dei piccoli agricoltori.

Per la cura del giardino un ricco **Catalogo Attrezzature** offre carrelli spandiconcime, macchine irroratrici per il prato, seminatrici di precisione per orto, trapiantatori per piantine e raccoglitori per frutta a terra; articoli di nostra esclusiva che rendono veloci e leggeri i lavori di semina, trapianto e raccolta e ci consentono di proporci come distributori su tutto il territorio nazionale.



RICHIEDI IL LISTINO ATTREZZATURE



ATTREZZA LA TUA PASSIONE

MUGGIOLI GIARDINAGGIO s.r.l.
Via Visentin, 11
31050 Ponzano Veneto - (Treviso) ITALIA

Tel. +39 0422 969990
fax. +39 0422 967753

info@muggioligiardinaggio.com
www.muggioligiardinaggio.com

PAGINA **IRRIGAZIONE A SCOMPARSA**

- 3-4-5-6-7 • IRRIGAZIONE HUNTER
- 8-9 • IRRIGAZIONE RAIN BIRD
- 10 • ELETTRIVALVOLE E PROGRAMMATORI RPE/PROVALVE IRRITEC
- 11 • PROGRAMMATORI SOLEM - BACCARA - ELETTRIVALVOLE IRRITROL
- 12 • PROGRAMMATORI ORBIT
- 13 • IRRIGATORI K-RAIN - COLLETTORI RAIN
- 14 • SISTEMI DI DERIVAZIONE PER IRRIGATORI
- 15 • ACCESSORI
- 16 • POZZETTI PER ELETTRIVALVOLE - PUNTI ACQUA
- 17-18 • COLLETTORI PER ELETTRIVALVOLE
- 19 • TUBO POLIETILENE - PRESE A STAFFA
- 20-21-22 • RACCORDERIA A COMPRESSIONE CONNECTO
- 23 • VALVOLE A SFERA
- 24-25 • RACCORDERIA FILETTATA
- 26-27 • RACCORDERIA IN OTTONE
- 28 • ELETTROPOMPE ED ACCESSORI
- 29 • IRRIGATORI A BATTENTE E TREPPEDI

PAGINA **IRRIGAZIONE A GOCCIA**

- 30-31 • ACCESSORI PER IRRIGAZIONE A GOCCIA
- 32 • FILTRAZIONE
- 33-34-35 • ALA GOCCIOLANTE E MANICHETTA PIATTA
- 36-37-38-39 • RACCORDERIA Ø 16 E 20 PER IRRIGAZIONE A GOCCIA
- 40 • MINIVALVOLE A CILINDRO COMPACT
- 41 • GOCCIOLATORI I-DROP - SISTEMA CAPILLARE
- 42 • MICROTUBI E INNESTI MICROTUBO
- 43 • MICROIRRIGAZIONE EINDOR
- 44-45-46-47 • MICROIRRIGAZIONE TECO

PAGINA **GIARDINAGGIO**

- 48-49-50-51-52 • LINEA COLORTAP
- 53 • TUBO DA GIARDINO FITT - CARRELLI AVVOLGITUBO TAMEC
- 54-55 • GREEN LINE SIROFLEX - ROMPIGETTO BLUE-LINE

PAGINA **BORDURE E ILLUMINAZIONE**

- 56 • BORDURE PER AIUOLE IN CORTEN
- 58 • ILLUMINAZIONE A LED PER ESTERNI



ROTATOR - UGELLO MULTIGETTO A RISPARMIO IDRICO

UGELLO MULTIGETTO MP ROTATOR



MP1000-RAGGIO DA 2,5 - 4,5 MT
MP2000-RAGGIO DA 4 - 6,4 MT
MP3000-RAGGIO DA 6,7 - 9,1 MT



CODICE	DESCRIZIONE	PREZZO (€)	CONF.	BOX	CAT.
RN.MP800Q	Rotator 800 reg. 90°/210° (arancio) da 1,8 a 3,5 mt	12,74	10	200	B
RN.MP800F	Rotator 800 fisso 360° (verde lime) da 1,8 a 3,5 mt	12,74	10	200	B
RN.MP815Q	Rotator 800 reg. 90°/210° (bordeau) da 2,5 a 4,9 mt	12,74	10	200	B
RN.MP815TQ	Rotator 800 reg. 210°/270° (blu chiaro) da 2,5 a 4,9 mt	12,74	10	200	B
RN.MP815F	Rotator 800 fisso 360° (verde oliva) da 2,5 a 4,9 mt	12,74	10	200	B
RN.MP1000C	Rotator 1000 regolabile 45°/105° (turchese)	12,74	10	200	B
RN.MP1000Q	Rotator 1000 regolabile 90°/210° (bordeau)	12,74	10	200	B
RN.MP1000TQ	Rotator 1000 regolabile 210°/270° (azzurro)	12,74	10	200	B
RN.MP1000F	Rotator 1000 fisso 360° (verdino)	12,74	10	200	B
RN.MP2000Q	Rotator 2000 regolabile 90°/210° (nero)	12,74	10	200	B
RN.MP2000TQ	Rotator 2000 regolabile 210°/270° (verde)	12,74	10	200	B
RN.MP2000F	Rotator 2000 fisso 360° (rosso)	12,74	10	200	B
RN.MP3000Q	Rotator 3000 regolabile 90°/210° (blu)	12,74	10	200	B
RN.MP3000TQ	Rotator 3000 regolabile 210°/270° (giallo)	12,74	10	200	B
RN.MP3000F	Rotator 3000 fisso 360° (grigio)	12,74	10	200	B
RN.MP3500Q	Rotator 3500 reg. 90°/210° da 9,1/10,7 mt (beige)	12,74	10	200	B
RN.MPLEFT	Rotator striscia sinistra (bianco)	12,74	10	200	B
RN.MPRIGHT	Rotator striscia destra (ruggine)	12,74	10	200	B
RN.MPSIDE	Rotator lato-striscia (marrone)	12,74	10	200	B
RN.MPKEY	Chiavetta regolazione Rotator	1,84	10	-	B
RN.MPADAPT	Adattatore per rilevamento pressione	3,20	1	-	B
RN.MP1000Q-M	Rotator 1000 regolabile 90°/210° filetto maschio	15,41	10	200	B
RN.MP2000Q-M	Rotator 2000 regolabile 90°/210° filetto maschio	15,41	10	200	B
RN.MP3000Q-M	Rotator 3000 regolabile 90°/210° filetto maschio	15,41	10	200	B



PROGRAMMATORE HC CON SOFTWARE
BASATO SU WEB HYDRAWISE™

PROGRAMMATORE WI-FI



CODICE	DESCRIZIONE	PREZZO (€)	CONF.	BOX	CAT.
HU.HC6	Programmatore 6 zone trasf. esterno	330,62	1	-	B
HU.HC12	Programmatore 12/24 zone espandibile trasf. esterno	385,13	1	-	B
HU.HC12M	Modulo espansione 12 zone Wi-Fi	207,38	1	-	B
HU.PHC6	Programmatore 6 zone connessione Wi-Fi tr. interno	385,13	1	-	B
HU.PHC12	Programmatore 12 zone connessione Wi-Fi tr. interno	472,82	1	-	B
HU.HC75	Misuratore di portata 3/4"	207,38	1	-	B
HU.HC100	Misuratore di portata 1"	235,82	1	-	B

ASSUMETE IL CONTROLLO DELLA VOSTRA IRRIGAZIONE IN QUALSIASI MOMENTO, OVUNQUE VI TROVIATE RIDUCETE IL NUMERO DI RICHIESTE DI ASSISTENZA COSTOSE ACCEDENDO DA CELLULARE, TABLET O COMPUTER AI COMANDI DEL VOSTRO IMPIANTO DI IRRIGAZIONE, IN QUALSIASI MOMENTO, OVUNQUE VI TROVIATE.





IRRIGATORI STATICI E UGELLI HUNTER



PSU

IRRIGATORE 1/2" F. COMPLETO DI
UGELLO INTERCAMBIABILE

STATICO REGOLABILE 0°/360°

CODICE	GITTATA	PREZZO (€)	ALZO	BOX	CAT.
HU.S022.08A	2,5 MT	3,56	5 cm	100	B
HU.S022.10A	3,0 MT	3,56	5 cm	100	B
HU.S022.12A	3,7 MT	3,56	5 cm	100	B
HU.S022.15A	4,6 MT	3,56	5 cm	100	B
HU.S024.08A	2,5 MT	3,56	10 cm	100	B
HU.S024.10A	3,0 MT	3,56	10 cm	100	B
HU.S024.12A	3,7 MT	3,56	10 cm	100	B
HU.S024.15A	4,6 MT	3,56	10 cm	100	B
HU.S024.17A	5,2 MT	3,56	10 cm	100	B
HU.PSU02	senza ugello	3,14	5 cm	100	B
HU.PSU04	senza ugello	3,32	10 cm	100	B



PRS30

IRRIGATORE 1/2"
AUTOCOMPENSANTE PER STATICI

CORPO IRRIGATORE FISSO 2,1 BAR

CODICE	GITTATA	PREZZO (€)	ALZO	BOX	CAT.
HU.SPRAY.04	alzo 10 cm	9,01	10 cm	50	B



PRS40

IRRIGATORE 1/2"
AUTOCOMPENSANTE PER ROTATOR

CORPO IRRIGATORE FISSO 2,8 BAR

CODICE	GITTATA	PREZZO (€)	ALZO	BOX	CAT.
HU.PRO40CV	alzo 10 cm	11,85	10 cm	50	B



UGR

TESTINA PER POP-UP A
SETTORE VARIABILE

UGELLO REGOLABILE 0°/360°

CODICE	GITTATA	PREZZO (€)	CONF.	BOX	CAT.
HU.UGR04A	1,2 MT	1,78	25	250	B
HU.UGR06A	1,8 MT	1,78	25	250	B
HU.UGR08A	2,4 MT	1,78	25	250	B
HU.UGR10A	3,0 MT	1,78	25	250	B
HU.UGR12A	3,7 MT	1,78	25	250	B
HU.UGR15A	4,6 MT	1,78	25	250	B
HU.UGR17A	5,2 MT	1,78	25	250	B



STRIP

UGELLI SPECIALI A STRISCIA

CODICE	GITTATA	PREZZO (€)	CONF.	BOX	CAT.
HU.15RST	destra	2.07	25	250	B
HU.15SST	lato striscia	2.07	25	250	B
HU.SS-918	striscia alta	2.07	25	250	B
HU.15LST	sinistra	2.07	25	250	B
HU.15CST	centro striscia	2.07	25	250	B
HU.15EST	fine striscia	2.07	25	250	B



PRO

IRRIGATORE 1/2" SOLO CORPO
SENZA UGELLO

CORPO IRRIGATORE PRO-SPRAY

CODICE	GITTATA	PREZZO (€)	ALZO	BOX	CAT.
HU.PRO.02	alzo 5 cm	3,08	5 cm	50	B
HU.PRO.03	alzo 7,5 cm	3,08	7,5 cm	50	B
HU.PRO.04	alzo 10 cm	3,08	10 cm	50	B
HU.PRO.06	alzo 15 cm	14,22	15 cm	50	B
HU.PRO.12	alzo 30 cm	18,96	30 cm	50	B
HU.PRO00	adattatore 1/2"	1,36	-	100	B



AD

VALVOLA ANTIDRENAGGIO

CODICE	GITTATA	PREZZO (€)	CONF.	BOX	CAT.
HU.PS-AD	per serie PS	1,07	25	-	B
HU.PRO-AD	per serie PRO	1,19	25	-	B



UGELLI ARCO FISSO

CODICE	GITTATA	PREZZO (€)	CONF.	BOX	CAT.
HU.5Q	1,5 MT 90°	1,78	25	250	B
HU.5H	1,5 MT 180°	1,78	25	250	B
HU.5F	1,5 MT 360°	1,78	25	250	B
HU.8Q	2,4 MT 90°	1,78	25	250	B
HU.8H	2,4 MT 180°	1,78	25	250	B
HU.8F	2,4 MT 360°	1,78	25	250	B
HU.10Q	3,0 MT 90°	1,78	25	250	B
HU.10H	3,0 MT 180°	1,78	25	250	B
HU.10F	3,0 MT 360°	1,78	25	250	B
HU.12Q	3,6 MT 90°	1,78	25	250	B
HU.12H	3,6 MT 180°	1,78	25	250	B
HU.12F	3,6 MT 360°	1,78	25	250	B
HU.15Q	4,5 MT 90°	1,78	25	250	B
HU.15T	4,5 MT 120°	1,78	25	250	B
HU.15H	4,5 MT 180°	1,78	25	250	B
HU.15TQ	4,5 MT 270°	1,78	25	250	B
HU.15F	4,5 MT 360°	1,78	25	250	B



UGELLI CORTA GITTATA

CODICE	GITTATA	PREZZO (€)	CONF.	BOX	CAT.
HU.2Q	0,6 MT 90°	1,78	25	250	B
HU.2H	0,6 MT 180°	1,78	25	250	B
HU.4Q	1,2 MT 90°	1,78	25	250	B
HU.4H	1,2 MT 180°	1,78	25	250	B
HU.6Q	1,8 MT 90°	1,78	25	250	B
HU.6H	1,8 MT 180°	1,78	25	250	B

IRRIGATORI A TURBINA



RAGGIO: DA 4,0 A 9,4 M
PORTATE: DA 0,08 A 0,82 M³/ORA; DA 1,4 A 13,7 L/MIN
FILETTO INGRESSO: 1/2" NPT

TURBINA HUNTER SRM



CODICE	DESCRIZIONE	PREZZO (€)	CONF.	BOX	CAT.
HU.S050.ADJ	Irrigatore a turbina SRM alzo 10 cm	14,81	1	25	B
HU.PGM-AD	Antidrain per turbina SRM Hunter	0,89	25	-	B
HU.463262	Viite rompigitto SRM	0,59	10	-	B



RAGGIO: DA 4,3 M A 11,6 M
PORTATE: DA 0,13 A 1,23 M³/ORA; DA 2,2 A 20,5 L/MIN
FILETTO INGRESSO: 1/2" NPT

TURBINA HUNTER PGJ



CODICE	DESCRIZIONE	PREZZO (€)	CONF.	BOX	CAT.
HU.S060.ADJ	Irrigatore a turbina PGJ alzo 10 cm	15,41	1	25	B
HU.PGJ-AD	Valvola antidrain per PGJ	0,89	25	-	B
HU.S060.VR	Vite rompigitto per PGJ	0,59	10	-	B



RAGGIO: DA 6,4 A 15,8 M
PORTATE: DA 0,10 A 3,22 M³/ORA; DA 1,7 A 53,7 L/MIN
FILETTO INGRESSO: 3/4" NPT

TURBINA HUNTER PGP



CODICE	DESCRIZIONE	PREZZO (€)	CONF.	BOX	CAT.
HU.S075.ADJ	Irrigatore a turbina PGP alzo 10 cm	17,78	1	20	B
HU.PGP-AD	Antidrain per PGP	1,19	25	-	B
HU.S075.VR	Vite rompigitto per PGP	0,59	10	-	B



RAGGIO: DA 4,9 A 14,0 M - 22 UGELLI
PORTATE: DA 0,07 A 3,23 M³/ORA; DA 1,2 A 53,8 L/MIN
FILETTO INGRESSO: 3/4" NPT - ARCO REGISTR. DA 50° A 360°

TURBINA HUNTER PGP ULTRA



CODICE	DESCRIZIONE	PREZZO (€)	CONF.	BOX	CAT.
HU.PGPULTRA	Irrigatore a turbina PGP ULTRA alzo 10 cm	18,96	1	20	B



RAGGIO: DA 4,9 A 14,0 M
PORTATE: DA 0,07 A 3,23 M³/ORA; DA 1,2 A 53,8 L/MIN
FILETTO INGRESSO: 3/4" NPT - FLOW-STOP

TURBINA HUNTER I-20



CODICE	DESCRIZIONE	PREZZO (€)	CONF.	BOX	CAT.
HU.I20.ADV	Irrigatore a turbina Flow-Stop pistone ABS alzo 10 cm	29,63	1	20	B
HU.I20.ADS	Irrigatore a turbina Flow-Stop pistone inox alzo 10 cm	41,48	1	20	B



RAGGIO: DA 14,0 A 21,6 M
PORTATE: DA 0,82 A 7,24 M³/ORA; DA 13,6 A 120,07 L/MIN
FILETTO INGRESSO: 1" NPT

TURBINA HUNTER I-25



CODICE	DESCRIZIONE	PREZZO (€)	CONF.	BOX	CAT.
HU.I25-ADJ	Irrigatore a turbina alzo 10 cm	65,17	1	12	B



RAGGIO: DA 13,1 A 23,2 M
PORTATE: DA 1,63 A 6,84 M³/ORA; DA 27,2 A 114,1 L/MIN
FILETTO INGRESSO: 1" NPT

TURBINA HUNTER I-40



CODICE	DESCRIZIONE	PREZZO (€)	CONF.	BOX	CAT.
HU.I40.ADS	Irrigatore Hunter I40 alzo 10cm pistone Inox	129,17	1	12	B
HU.I40-U	Ugelli	2,96	12	-	B
HU.I40.KIT	Portazolla per I41	47,40	1	-	B



HUNTER

ACCESSORI



CODICE	DESCRIZIONE	PREZZO (€)	CONF.	BOX	CAT.
HU.KEY	Chiave per Hunter	0,59	1	100	B
HU.CSU	Collare sostituzione ugelli	1,19	1	-	B



PGV

MEMBRANA AD ALTE PRESTAZIONI SENZA PERDITE
PRESSIONE CONSIGLIATA DA 1,5 A 10 ATM
PORTATA MASSIMA 115 LT/H - SPURGO MANUALE INTERNO

**ELETTROVALVOLA HUNTER
24 V**

CODICE	DESCRIZIONE	PREZZO (€)	CONF.	BOX	CAT.
HU.PGV101	1" F/F 24V con controllo di flusso	26,66	1	20	B
HU.PGV101-M	1" M/M 24V con controllo di flusso	26,66	1	20	B
HU.PGV151	1"½ F/F 24V con controllo di flusso	79,40	1	6	B
HU.PGV201	2" F/F 24V con controllo di flusso	97,17	1	4	B
HU.SOL24V	Solenioide 24V	15,41	1	10	B



REGOLATORE DI PRESSIONE ACCU-SYNC

HU.ACCUS20	Regolatore di pressione pretarato 1,4 bar	54,51	1	10	B
HU.ACCUS30	Regolatore di pressione pretarato 2,1 bar	54,51	1	10	B
HU.ACCUS40	Regolatore di pressione pretarato 3,0 bar	54,51	1	10	B
HU.ACCUS50	Regolatore di pressione pretarato 3,5 bar	54,51	1	10	B



ELC

INSTALLAZIONE ALL'INTERNO - 3 PROGRAMMI
4 PARTENZE GIORNALIERE - TEMPI FINO A 240 MINUTI
INGRESSO SENSORI - MEMORIA PERMANENTE - WATER BDG

**PROGRAMMATORE 24 V
TRASFORMATORE ESTERNO**

CODICE	DESCRIZIONE	PREZZO (€)	CONF.	BOX	CAT.
HU.ELC4	4 zone trasformatore esterno 24 V	60,44	1	10	B
HU.ELC6	6 zone trasformatore esterno 24 V	68,71	1	10	B



CCLO MANUALE - RITARDO IRRIGAZIONE PROGRAMMABILE
MEMORIA PERMANENTE - PROTEZIONE CORTO CIRCUITI
WATER BDG% - PROGRAMMABILE CON SOLAR SYNC

**PROGRAMMATORE
24 V**

CODICE	DESCRIZIONE	PREZZO (€)	CONF.	BOX	CAT.
HU.XC201I-E	2 zone trasformatore esterno 24 V	88,88	1	10	B
HU.XC401I-E	4 zone trasformatore esterno 24 V	100,73	1	10	B
HU.XC601I-E	6 zone trasformatore esterno 24 V	112,58	1	10	B
HU.XC801I-E	8 zone trasformatore esterno 24 V	142,20	1	10	B
HU.XC34	4 zone trasformatore interno 24 V	154,05	1	10	B
HU.XC36	6 zone trasformatore interno 24 V	177,75	1	10	B
HU.XC38	8 zone trasformatore interno 24 V	213,30	1	10	B



PRO-C

CCLO MANUALE - RITARDO IRRIGAZIONE PROGRAMMABILE
MEMORIA PERMANENTE - COMPATIBILE CON ROAM
WATER BDG% - COMPATIBILE CON TUTTI I SENSORI

**PROGRAMMATORE 24 V
ESPANDIBILE DA 4 A 16 ZONE**

CODICE	DESCRIZIONE	PREZZO (€)	CONF.	BOX	CAT.
HU.PRO-CI	4 zone espandibile a 16 (**)	225,15	1	10	B
HU.RCM3	Scheda di espansione a 3 zone	68,73	1	-	B
HU.RCM9	Scheda di espansione a 9 zone	254,78	1	-	B



PCC

CCLO MANUALE - RITARDO IRRIGAZIONE PROGRAMMABILE
MEMORIA PERMANENTE - COMPATIBILE CON ROAM
WATER BDG% - PROGRAMMABILE CON SOLAR SYNC

**PROGRAMMATORE 24 V
TRASFORMATORE INTERNO**

CODICE	DESCRIZIONE	PREZZO (€)	CONF.	BOX	CAT.
HU.PCC6	6 zone trasformatore interno 24 V	242,93	1	10	B
HU.PCC12	12 zone trasformatore interno 24 V	325,88	1	10	B



I-CORE

PROGRAMMATORE MODULARE - 4 PROGRAMMI
8 PARTENZE - 16 SU PROGRAMMA D - TEMPI: 12 ORE
SMART PORT INSTALLATA - DISPLAY IN ITALIANO

**PROGRAMMATORE 24 V
ESPANDIBILE DA 6 A 32 ZONE**

CODICE	DESCRIZIONE	PREZZO (€)	CONF.	BOX	CAT.
HU.IC601PL	6 zone espandibile trasformatore interno	551,03	1	10	B
HU.ICM600	Modulo di espansione 6 zone	132,72	1	10	B

ELETTROVALVOLE E PROGRAMMATORI A BATTERIA 9 VDC

Hunter
Gli Innovatori dell'Irrigazione



PGV

MEMBRANA AD ALTE PRESTAZIONI SENZA PERDITE
PRESSIONE CONSIGLIATA DA 1,5 A 10 ATM
PORTATA MASSIMA 115 LT/H - SPURGO MANUALE INTERNO

ELETTROVALVOLA HUNTER 9 VDC

CODICE	DESCRIZIONE	PREZZO (€)	CONF.	BOX	CAT.
HU.PGV1DC	1" F/F 9V con controllo di flusso	47,40	1	20	B
HU.PGV1DC-MM	1" M/M 9V con controllo di flusso	47,99	1	20	B
HU.PGV151DC	1"½ F/F 9V con controllo di flusso	100,73	1	6	B
HU.PGV201DC	2" F/F 9V con controllo di flusso	118,50	1	4	B
HU.SVC9DC	Solenoido 9V	23,70	1	10	B

NEW



NODE

IP68 - 3 PROGRAMMI - CICLO MANUALE - WATER BDG
4 PARTENZE GIORNALIERE - TEMPI FINO A 360 MINUTI
INGRESSO SENSOR- DISTANZA MAX DAL SOLENOIDE 30 MT

PROGRAMMATORE A BATTERIA

CODICE	DESCRIZIONESEN	PREZZO (€)	CONF.	BOX	CAT.
HU.N1E	1 zona completo di valvola 1"	162,35	1	10	B
HU.N1	1 zona SENZA solenoide	-	1	10	B
HU.N2	2 zone SENZA solenoidi	195,53	1	10	B
HU.N4	4 zone SENZA solenoidi	231,08	1	10	B
HU.N6	6 zone SENZA solenoidi	266,63	1	10	B



H-CORE

CICLO MANUALE - RITARDO IRRIGAZIONE PROGRAMMABILE
MEMORIA PERMANENTE - PROTEZIONE CORTO CIRCUITI
WATER BDG% - SENSORI SENZA FILI NON COMPATIBILI

PROGRAMMATORE A BATTERIA

CODICE	DESCRIZIONE	PREZZO (€)	CONF.	BOX	CAT.
HU.XCH6	6 zone	237,00	1	10	B
HU.XCH12	12 zone	343,65	1	10	B

SENSORI PER RISPARMIO IDRICO

Hunter
Gli Innovatori dell'Irrigazione

SENSORI PIOGGIA



SEN

PER INTERROMPERE L'IRRIGAZIONE IN CASO DI PIOGGIA
INSTALLABILE SU QUALSIASI PROGRAMMATORE
ANELLO DI VENTILAZIONE REGOLABILE

CODICE	DESCRIZIONE	PREZZO (€)	CONF.	BOX	CAT.
HU.MINICLICK	Sensore pioggia Miniclic con 7,5 mt di cavo	48,59	1	24	B
HU.RAINCLICK	Sensore pioggia a risposta veloce	48,59	1	24	B



SOLAR

SOLAR SYNC MONITORIZZA OGNI GIORNO IL TEMPO LOCALE E REGOLA I TEMPI D'IRRIGAZIONE RENDENDO PIÙ INTEL-LIGENTI I PROGRAMMATORI HUNTER

SOLAR SYNC

CODICE	DESCRIZIONE	PREZZO (€)	CONF.	BOX	CAT.
HU.SOLAR-SENS	Sensore automatico SOLAR SYNC per I-CORE / XCORE	142,20	1	-	B
HU.SOLAR-S	Sensore automatico SOLAR SYNC completo	183,68	1	-	B



SOLAR

SOLAR SYNC MONITORIZZA OGNI GIORNO IL TEMPO LOCALE E REGOLA I TEMPI D'IRRIGAZIONE RENDENDO PIÙ INTEL-LIGENTI I PROGRAMMATORI HUNTER

SOLAR SYNC WIRELESS

CODICE	DESCRIZIONE	PREZZO (€)	CONF.	BOX	CAT.
HU.WSS-SENS	Sensore wireless SOLAR SYNC per I-CORE / XCORE	266,63	1	-	B





*FLUSSO CON DOPPIO FILTRAGGIO
SOLENOIDE INCAPSULATO A BASSO CONSUMO
ROBUSTA COSTRUZIONE IN PVC*

**ELETTROVALVOLA
DV100 24V**

CODICE	DESCRIZIONE	PREZZO (€)	CONF.	BOX	CAT.
RB.DV100	Elettrovalvola 1" F/F 24V	30,10	1	20	C
RB.DV-100-MM	Elettrovalvola 1" M/M 24V	30,10	1	20	C
RB.SOL24	Solenoido 24 V per serie DV	19,61	1	10	C



*FLUSSO CON DOPPIO FILTRAGGIO
SOLENOIDE INCAPSULATO A BASSO CONSUMO
ROBUSTA COSTRUZIONE IN PVC*

**ELETTROVALVOLA
DV100 9VDC**

CODICE	DESCRIZIONE	PREZZO (€)	CONF.	BOX	CAT.
RB.DV100-9V	Elettrovalvola 1" F/F per sistemi a batteria	48,29	1	20	C
RB.DV100MM-9V	Elettrovalvola 1" M/M per sistemi a batteria	48,29	1	20	C
RB.LU3100	Solenoido bistabile 9 V LU3100	38,26	1	10	C



*PROGRAMMATORE PER AMBIENTI INTERNI 4,6,8 STAZIONI
4 PARTENZE AL GIORNO - WATER BUDGET % - RITARDO
PIOGGIA - TEMPI DA 0 A 240 MIN. - 17,8 X15,2X3,2 CM*

**PROGRAMMATORE A 230 VCA
RZX - WIFI COMPATIBILE**

CODICE	DESCRIZIONE	PREZZO (€)	CONF.	BOX	CAT.
RB.RZX4	Programmatore 4 zone trasf. esterno WIFI compatibile	94,38	1	6	C
RB.RZX6	Programmatore 6 zone trasf. esterno WIFI compatibile	106,51	1	6	C
RB.RZX8	Programmatore 8 zone trasf. esterno WIFI compatibile	125,76	1	6	C
RB.LNKWF	Modulo WIFI per programmatore	135,00	1	6	C



*PROGRAMMATORE PER AMBIENTI ESTERNI 4,6,8 STAZIONI
4 PARTENZE AL GIORNO - WATER BUDGET % - RITARDO
PIOGGIA - TEMPI DA 0 A 240 MIN. -*

**PROGRAMMATORE A 230 VCA
RZX - WIFI COMPATIBILE**

CODICE	DESCRIZIONE	PREZZO (€)	CONF.	BOX	CAT.
RB.RZX34	Programmatore 4 zone trasf. int. WIFI compatibile	148,37	1	6	C
RB.RZX36	Programmatore 6 zone trasf. int. WIFI compatibile	170,84	1	6	C
RB.RZX38	Programmatore 8 zone trasf. int. WIFI compatibile	208,01	1	6	C
RB.LNKWF	Modulo WIFI per programmatore	135,00	1	6	C



*PROGRAMMATORE PER AMBIENTI ESTERNI ESPANDIBILE
4 PARTENZE AL GIORNO - WATER BUDGET % - RITARDO
PIOGGIA - TEMPI DA 0 A 240 MIN. -*

**PROGRAMMATORE A 230 VCA
ESPANDIBILE 4/22 ZONE**

CODICE	DESCRIZIONE	PREZZO (€)	CONF.	BOX	CAT.
RB.ESPME	Programmatore 4 zone trasformatore interno	235,84	1	6	C
RB.ESPM3	Espansione 3 zone	45,85	1	6	C
RB.ESPM6	Espansione 6 zone	82,47	1	6	C



*ALIMENTAZIONE CON 2 BATTERIE 9V
TRE PROGRAMMI INDIPENDENTI
IP 68 COMPLETAMENTE SOMMERSIBILE*

**PROGRAMMATORE A BATTERIA
SERIE WP**

CODICE	DESCRIZIONE	PREZZO (€)	CONF.	BOX	CAT.
RB.WPX1KIT	Programmatore 1 zona batteria con elettrovalvola 1"	135,79	1	6	C
RB.WPX1	Programmatore 1 zona batteria	105,96	1	6	C
RB.WPX2	Programmatore 2 zone batteria	182,53	1	6	C
RB.WPX4	Programmatore 4 zone batteria	199,23	1	6	C
RB.WPX6	Programmatore 6 zone a batteria	224,83	1	6	C





IRRIGATORE STATICO RAINBIRD



IRRIGATORE POP-UP COMPATIBILE CON UGELLI FEMMINA
ALZO 10 CM - MOLLA DI RICHIAMO IN ACCIAIO INOX
ATTACCO DA 1/2"

**CORPO POP-UP
1804**

CODICE	DESCRIZIONE	PREZZO (€)	CONF.	BOX	CAT.
RB.18004R	Irrigatore statico RainBird alzo 10 cm	3,13	1	75	C



TESTINE CON ARCO FACILMENTE REGOLABILE
GITTATE DA 0,9 MT FINO A 5,5
TESTINE COLORATE FACILI DA RICONOSCERE

**UGELLI REGOLABILI
VAN**

CODICE	DESCRIZIONE	PREZZO (€)	CONF.	BOX	CAT.
RB.VAN04	0°-330° giallo, traiettoria 0° , gittata 1,2 mt	1,99	25	250	C
RB.VAN06	0°-330° arancio, traiettoria 0° gittata 1,8 mt	1,99	25	250	C
RB.VAN08	0°-360° verde, traiettoria 5° gittata 2,4 mt	1,99	25	250	C
RB.VAN10	0°-360° blue, traiettoria 10° gittata 3,0 mt	1,99	25	250	C
RB.VAN12	0°-360° marrone, traiettoria 15° gittata 3,6 mt	1,99	25	250	C
RB.VAN15	0°-360° nero, traiettoria 23° gittata 4,5 mt	1,99	25	250	C
RB.VAN18	0°-360° beige, traiettoria 26° gittata 5,4 mt	1,99	25	250	C



IRRIGATORI A TURBINA RAINBIRD



IRRIGATORE PER GITTATE MEDIO-CORTE DA 4,6 A 10,7 MT
ARCO REGOLABILE DA 40° A 360° - ATTACCO 1/2" F.
PRECIPITAZIONI TRA 10 E 18 MM/H

**TURBINA RAINBIRD
3504**

CODICE	DESCRIZIONE	PREZZO (€)	CONF.	BOX	CAT.
RB.3504PC	Irrigatore turbina 1/2" alzo 10 cm.	13,89	1	25	C



IRRIGATORE PER GITTATE MEDIO-LUNGHE DA 7,6 A 15,2 MT
ARCO REGOLABILE DA 40° A 360° - ATTACCO 3/4" F.
PRECIPITAZIONI TRA 6 E 18 MM/H

**TURBINA RAINBIRD
5004**

CODICE	DIAMETRO INTERNO 12,5 MM	DESCRIZIONE	PREZZO (€)	CONF.	BOX	CAT.
RB.5004PC		Irrigatore turbina 5004 Plus PC - 3/4" arco reg.	15,10	1	20	C
RB.5004PC/PLUS		Irrigatore turbina 5004 SAM	18,41	1	20	C



IRRIGATORE PER GITTATE MEDIO-LUNGHE DA 6,7 A 13,7 MT
ARCO REGOLABILE DA 20°/ 340° - OPPURE 360°.
PRECIPITAZIONI TRA 10 E 20 MM/H - ATTACCO 1/2 F.

**IRRIGATORE RAINBIRD
MAXI PAWN**

CODICE	DESCRIZIONE	PREZZO (€)	CONF.	BOX	CAT.
RB.MP	Irrigatore Maxi Paw sollevamento 7,6 cm	40,24	1	10	C



TECNOLOGIA ANTINTRUSIONE Ø 16 - SPESSORE 1,2 MM
SPAZIATURA 33 CM PORTATA 2,3 LT/H
PRESSIONE D'ES. DA 0,6 A 4 BAR - BOBINA DA 100 MT

ALA GOCCIOLANTE XFS/XFD

CODICE	DESCRIZIONE	PREZZO (€)	CONF.	BOX	CAT.
RB.X44202	colore marrone mt 100	81,20	100	-	C
RB.XFS33100	colore marrone autocompensante interrabile mt 100	112,50	100	-	C



ELETTROVALVOLE RPE/IRRITEC PRO-VALVE

VPN

CORPO IN NYLON E FIBRA DI VETRO
PRESSIONE D'ESERCIZIO DA 0,5 12 BAR
SOLENOIDE A TENUTA IP 67

ELETTROVALVOLE 24V RPE/IRRITEC



CODICE	DESCRIZIONE	PREZZO (€)	CONF.	BOX	CAT.
IR.VPN250	Elettrovalvola 3/4" F/F con controllo di flusso	24,00	1	30	B
IR.VPN320	Elettrovalvola 1" F/F con controllo di flusso	24,00	1	24	B
IR.VPN250M	Elettrovalvola 3/4" M/M con controllo di flusso	21,07	1	24	B
IR.VPN320M	Elettrovalvola 1" M/M con controllo di flusso	21,49	1	24	B
IR.VPN400	Elettrovalvola 1 1/4" F/F con controllo di flusso	35,00	1	12	B
IR.VPN500	Elettrovalvola 1 1/2" F/F con controllo di flusso	53,90	1	12	B
IR.VPN630	Elettrovalvola 2" F/F con controllo di flusso	76,00	1	12	B
IR.VPN900	Elettrovalvola 3" F/F con controllo di flusso	135,50	1	12	B
IR.SOL5	Solenoido 24 Vac	12,08	1	-	B



CORPO IN NYLON E FIBRA DI VETRO
PRESSIONE D'ESERCIZIO DA 0,05 12 BAR

ELETTROVALVOLA LOW-PRESSURE



CODICE	DESCRIZIONE	PREZZO (€)	CONF.	BOX	CAT.
IR.VLN320	Elettrovalvola 1" F/F con controllo di flusso	42,40	1	24	B



TENUTA STAGNA IP68, ALIMENTAZIONE CON PILA ALK 9V
PREDISPOSIZIONE SENSORI - FUNZIONA SOLO CON ELET-
TROVALVOLA 9VDC VPN NON INCLUSA

PROGRAMMATORE A PILE GREEN TIMER PRO



CODICE	DESCRIZIONE	PREZZO (€)	CONF.	BOX	CAT.
IR.GTP1	Programmatore a pile GREEN TIMER PRO 1 zona	76,95	1	18	B
IR.GTP2	Programmatore a pile GREEN TIMER PRO 2 zone	87,66	1	18	B
IR.GTP4	Programmatore a pile GREEN TIMER PRO 4 zone	96,40	1	18	B

VPN-DC

CORPO IN NYLON E FIBRA DI VETRO
PRESSIONE D'ESERCIZIO DA 0,5 12 BAR
SOLENOIDE 9VDC BISTABILE A TENUTA IP 67

ELETTROVALVOLE 9 VDC RPE/IRRITEC



CODICE	DESCRIZIONE	PREZZO (€)	CONF.	BOX	CAT.
IR.VPN320DC	Elettrovalvola 1" F/F con controllo di flusso	34,27	1	24	B
IR.VPN320MDC	Elettrovalvola 1" M/M con controllo di flusso	31,90	1	24	B
IR.SOL9	Solenoido bistabile 9V	24,27	1	-	B

NEI SOLENOIDI VPN 9VDC IL FILO ROSSO CORRISPONDE AL COMUNE

GT

ATTACCHI 3/4", PRESSIONE DI ESERCIZIO DA 0,5 A 8 BAR
RICHIEDONO 2 BATTERIE ALCALINE AAA NON INCLUSE
ATTACCO INNESTO RAPIDO NELLA PARTE INFERIORE

PROGRAMMATORE A PILE DA RUBINETTO



CODICE	DESCRIZIONE	PREZZO (€)	CONF.	BOX	CAT.
IR.GT1	Programmatore a pile GT EVO 3/4" rubinetto Durata dell'irrigazione da 1 a 120 minuti	36,37	1	10	B
IR.GT2	Programmatore a pile GT PRO (display) 3/4" rubinetto Durata irrigazione da 1 a 240 minuti, attacco sensore	53,53	1	10	B
IR.GTS	Sensore pioggia per GT2	21,08	1	-	B
IR.GTB1	Programmatore a pile BLUETOOTH 3/4" rubinetto Programmazione da smartphone (app gratuita)	88,05	1	10	B

PROGRAMMATORI A BATTERIA BLUETOOTH SOLEM



TENUTA STAGNA IP68, ALIMENTAZIONE CON PILA ALK 9V
3 PROGRAMMI 8 PARTENZE GIORNALIERE - PROGRAMMA-
ZIONE CON SMARTPHONE - CONNESSIONE SENSORE

**PROGRAMMATORE A PILE
BLETOOTH DT-PRO**



CODICE	DESCRIZIONE	PREZZO (€)	CONF.	BOX	CAT.
SM.BLIP1	Programmatore Bluetooth IP68 batteria 1 zona	115,00	1	18	B
SM.BLIP2	Programmatore Bluetooth IP68 batteria 2 zone	145,00	1	18	B
SM.BLIP4	Programmatore Bluetooth IP68 batteria 4 zone	165,00	1	18	B
SM.BLIP6	Programmatore Bluetooth IP68 batteria 6 zone	190,00	1	18	B

PROGRAMMATORI A BATTERIA BACCARA



FUNZIONA CON UNA PILA ALKALINE DA 9 VOLT INCLUSA
FUNZIONE OFF-RAIN
TRE PROGRAMMI INDIPENDENTI

**PROGRAMMATORI A BATTERIA
BACCARA**



CODICE	DESCRIZIONE	PREZZO (€)	CONF.	BOX	CAT.
BA.GV75	Programmatore a batteria senza elettrovalvola	66,10	1	10	B
BA.GV75E	Progr.batteria con E-V 1"	75,43	1	10	B



IP67 - PROGRAMMABILE DA SMARTPHONE O TABLET
BLUETOOTH 4.0 - DURATA BATTERIA 3 ANNI - FINO A 6 CICLI
D'IRRIGAZIONE AL GIORNO - PER E-V FINO A 2"

**PROGRAMMATORI A BATTERIA
BLUETOOTH BACCARA**

CODICE	DESCRIZIONE	PREZZO (€)	CONF.	BOX	CAT.
BA.GVB75E	Programmatore a batteria bluetooth con E-V 1"	120,83	1	4	B



PROGRAMMATORE A BATTERIA CON DISPLAY

**PROGRAMMATORE A PILE
DA RUBINETTO**

CODICE	DESCRIZIONE	PREZZO (€)	CONF.	BOX	CAT.
AT.9001D	Programmatore a batteria 1 zona	59,00	1	6	B

ELETTROVALVOLE IRRITROL - TORO



MINIMA PERDITA DI CARICO - CONTROLLO DI FLUSSO
APERTURA MANUALE SCARICO INTERNO
PRESSIONE DI ESERCIZIO DA 0,7 A 10 ATM

**ELETTROVALVOLA
ULTRAFLOW**



CODICE	DESCRIZIONE	PREZZO (€)	CONF.	BOX	CAT.
HA.VHJ020224	Elettrovalvola passaggio totale 3/4" senza solenoide	21,28	1	24	B
HA.VHJ020223	Elettrovalvola passaggio totale 24V 3/4" F/F	26,95	1	24	B
HA.700-1-LS	Elettrovalvola passaggio totale 24V 1" F/F	54,98	1	24	B
RI.2400S	Solenoide 24 VAC - 50Hz	10,26	1	10	B
HA.DCL	Solenoide 9 VDC per funzionamento a batteria	20,54	1	10	B



ELETTROVALVOLA 1" IN PVC RINFORZATO
APERTURA MANUALE SCARICO INTERNO
APERTURA CON GHIERA - FACILE MANUTENZIONE.

**ELETTROVALVOLA
2400**



CODICE	DESCRIZIONE	PREZZO (€)	CONF.	BOX	CAT.
RI.2400	Elettrovalvola 24V 1" F/F con controllo flusso	25,46	1	10	B
RI.2400M	Come sopra filetto M./M.	25,46	1	10	B



TEMPI DI IRRIGAZIONE: DA 1 A 99 MINUTI PER SETTORE-
TRASFORMATORE ESTERNO 24 V. - DOPPIO PROGRAMMA
COMANDO POMPA

PROGRAMMATORE TRASFORMATORE ESTERNO

CODICE	DESCRIZIONE	PREZZO (€)	CONF.	BOX	CAT.
RN.T4	Programmatore 4 zone ULTIMA	66,07	1	6	B
RN.T6	Programmatore 6 zone ULTIMA	74,89	1	6	B



PROGRAMMI A,B,C: 4 PARTENZE PER PROGRAMMA
"WATER BUDGET" - INGRESSO PER SENSORE PIOGGIA -
SCATOLA STAGNA CON CHIAVE

PROGRAMMATORE TRASFORMATORE INTERNO

CODICE	DESCRIZIONE	PREZZO (€)	CONF.	BOX	CAT.
RN.WM34	Programmatore 4 zone trasformatore interno	181,25	1	3	B
RN.WM36	Programmatore 6 zone trasformatore interno	225,71	1	3	B
RN.WM39	Programmatore 9 zone trasformatore interno	267,04	1	3	B
RN.WM312	Programmatore 12 zone trasformatore interno	321,29	1	3	B



COMPATIBILE CON SISTEMI IOS E ANDROID SI PUO' CO-
MANDARE ANCHE DA PC - MONTAGGIO SIA ALL'INTERNO
CHE ALL'ESTERNO - TRASFORMATORE INTERNO

PROGRAMMATORE WIFI TRASFORMATORE INTERNO

CODICE	DESCRIZIONE	PREZZO (€)	CONF.	BOX	CAT.
RN.BH6	Programmatore B-HYVE WIFI 6 zone trasf.interno	338,93	1	6	B
RN.BH12	Programmatore B-HYVE WIFI 12 zone trasf.interno	425,00	1	6	B

CON IL TIMER INTELLIGENTE WIFI B-HIVE TRAMITE LA PROPRIA RETE WIFI, CI SI COLLEGA AL CLIMA LOCALE E
INSIEME AD ALTRE INFORMAZIONI SULLA VOSTRA POSIZIONE LAVORERANNO PER FORNIRE LA GIUSTA QUANTITÀ DI
ACQUA ALLE VOSTRE PIANTE, ELIMINANDO GLI SPRECHI D'ACQUA. L'APP B-HYVE È MUNITA DI SCHERMATE E VIDEO
DI AIUTO PER FACILITARVI CON LE CONNESSIONI WIFI, LA PROGRAMMAZIONE, L'IRRIGAZIONE INTELLIGENTE E ALTRE
QUESTIONI DI CARATTERE GENERALE CHE POTRESTE DOVER AFFRONTARE.

APPLICAZIONE B-HYVE™

INSTALLARE L'APPLICAZIONE B-HYVE™ E CREARE UN ACCOUNT SUL PROPRIO DISPOSITIVO SMARTPHONE O TABLET DOPO AVER
INSTALLATO IL TIMER.



PER INTERRUPERE L'IRRIGAZIONE IN CASO DI PIOGGIA
INSTALLABILE SU QUALSIASI PROGRAMMATORE
ANELLO DI VENTILAZIONE REGOLABILE

SENSORI PIOGGIA/GELO HR100

CODICE	DESCRIZIONE	PREZZO (€)	CONF.	BOX	CAT.
IR.HR100	Sensore pioggia/gelo	41,64	1	6	B
IR.HR100W	Sensore pioggia/gelo Wireless	83,61	1	6	B



PROGRAMMATORE 3/4" CON VALVOLA INCORPORATA
AMICO1 E AMICO2 (2 ZONE INDIPENDENTI) - 4 PARTENZE
AL GIORNO TEMPI DA 1 A 240 MINUTI

PROGRAMMATORE A PILE DA RUBINETTO

CODICE	DESCRIZIONE	PREZZO (€)	CONF.	BOX	CAT.
RN.A1	Programmatore a batteria 1 zona	67,50	1	6	B
RN.A2	Programmatore a batteria 2 zone indipendenti	89,91	1	4	B





IRRIGATORI A TURBINA K-RAIN



5 UGELLI INTERCAMBIABILI - ARCO DA 40° A 360° -
PORTATA: DA 2,4 A 12,5 L/MIN GITTATA: DA 5,1 A 9,1 M
FILETTO INGRESSO: 1/2" NPT

TURBINA K-RAIN MINIPRO

CODICE	DESCRIZIONE	PREZZO (€)	CONF.	BOX	CAT.
RN.MINIPRO	Irrigatore turbina MiniPro	13,61	1	25	B
RN.MINI-AD	Valvola antidrenaggio per MiniPro	1,90	1	-	B



13 UGELLI INTERCAMBIABILI - ARCO REGOLABILE 40° 360°
PORTATA DA 1,9 A 37,9 L/MIN GITTATA: DA 8,5 A 13,4 M
FILETTO INGRESSO: 3/4" NPT

TURBINA K-RAIN SUPERPRO

CODICE	DESCRIZIONE	PREZZO (€)	CONF.	BOX	CAT.
RN.PROPLUS	Irrigatore a turbina SuperPro	17,50	1	20	B
RN.PRO-KEY	Chiave regolazione K-Rain	1,90	1	-	B



UGELLO REGOLABILE FIL.FEMMINA

CODICE	RAGGIO/MT	PREZZO (€)	CONF.	BOX	CAT.
RN.KF8A	2,4 MT	2,35	25	-	B
RN.KF10A	3,0 MT	2,35	25	-	B
RN.KF12A	3,7 MT	2,35	25	-	B
RN.KF15A	4,6 MT	2,35	25	-	B



UGELLO REGOLABILE FIL.MASCHIO

CODICE	RAGGIO/MT	PREZZO (€)	CONF.	BOX	CAT.
RN.KM8A	2,4 MT	2,35	25	-	B
RN.KM10A	3,0 MT	2,35	25	-	B
RN.KM12A	3,7 MT	2,35	25	-	B
RN.KM15A	4,6 MT	2,35	25	-	B

COLLETTORI PER ELETTROVALVOLE Ø 1" GHIERA LIBERA RAIN



CT

TEE 2 GHIERE M/F/F

CODICE	Ø	PREZZO (€)	CONF.	BOX	CAT.
RN.CT2320	1"	6,33	20	120	A



CC

CROCE

CODICE	Ø	PREZZO (€)	CONF.	BOX	CAT.
RN.CC3320	1"	9,10	20	-	A
RN.CC4320	1"	11,30	20	-	A



MAN

COLLETTORI 2/3/4 ZONE

CODICE	Ø	PREZZO (€)	CONF.	BOX	CAT.
RN.MAN2	2 zone 1"	17,90	1	60	A
RN.MAN3	3 zone 1"	25,30	1	50	A
RN.MAN4	4 zone 1"	33,00	1	40	A



CG

GOMITO

CODICE	Ø	PREZZO (€)	CONF.	BOX	CAT.
RN.CG1320	1 ghiera 1"	3,85	20	-	A
RN.CG2320	2 ghiera 1"	6,05	20	-	A



CM

MANICOTTO

CODICE	Ø	PREZZO (€)	CONF.	BOX	CAT.
RN.CM1320	1"	3,60	20	-	A
RN.CM2320	1"	6,05	20	-	A



CN

NIPPOLO CON O-R

CODICE	Ø	PREZZO (€)	CONF.	BOX	CAT.
RN.CN320	1"	3,03	20	-	A
RN.CN32C	1" x 3/4"	3,03	20	-	A

SISTEMI DI DERIVAZIONE PER IRRIGATORI - BLU-LOCK



GOMITO BLU-LOCK MASCHIO

CODICE	Ø	PREZZO (€)	CONF.	BOX	CAT.
RN.BL37970	16 x 1/2"	0,95	25	300	B
RN.BL37971	16 x 3/4"	0,95	25	300	B



GOMITO BLU-LOCK FEMMINA

CODICE	Ø	PREZZO (€)	CONF.	BOX	CAT.
RN.BL37972	16 x 1/2"	1,02	25	300	B
RN.BL37973	16 x 3/4"	1,06	25	300	B



ADATTATORE BLU-LOCK MASCHIO

CODICE	Ø	PREZZO (€)	CONF.	BOX	CAT.
RN.BL37974	16 x 1/2"	0,95	25	300	B
RN.BL37975	16 x 3/4"	0,95	25	300	B



GIUNZIONE BLU-LOCK

CODICE	Ø	PREZZO (€)	CONF.	BOX	CAT.
RN.BL37976	16 x 16	1,50	25	300	B



GOMITO BLU-LOCK FEMMINA

CODICE	Ø	PREZZO (€)	CONF.	BOX	CAT.
RN.BL37977	16 x 16 X 16	2,20	25	300	B



TUBO BLU-LOCK 30 MT

CODICE	Ø	PREZZO (€)	CONF.	BOX	CAT.
RN.BL37980	16	40,19	25	-	B

SISTEMI DI DERIVAZIONE PER IRRIGATORI - FLEX-HOSE



TUBO FLEXHOSE ANTITORSIONE

CODICE	Ø	PREZZO (€)	CONF.	BOX	CAT.
HA.EHD1215	30 MT - Ø 16	45,70	1	-	B
IR.TPP250	30 MT - Ø 20	46,50	1	-	B



GOMITO AUTOFILETTANTE MASCHIO

CODICE	Ø	PREZZO (€)	CONF.	BOX	CAT.
HA.FEM1515	16 x 1/2"	0,96	50	300	B
HA.FEM1520	16 x 3/4"	0,96	50	300	B
HA.ELS2015	20 x 1/2"	0,96	50	300	B
HA.ELS2020	20 x 3/4"	0,96	50	300	B



GFP

GOMITO AUTOFILETTANTE MASCHIO

CODICE	Ø	PREZZO (€)	CONF.	BOX	CAT.
IR.GFP16B	16 x 1/2"	0,36	100	1000	B
IR.GFP16C	16 x 3/4"	0,36	100	800	B



RFP

RACCORDO M. AUTOFILETTANTE

CODICE	Ø	PREZZO (€)	CONF.	BOX	CAT.
IR.RFP16B	16 x 1/2"	0,36	100	1000	B
IR.RFP16C	16 x 3/4"	0,36	100	900	B

PROLUNGHE A SEGMENTI



PRS

PROLUNGA A SEGMENTI 15 CM

CODICE	Ø	PREZZO (€)	CONF.	BOX	CAT.
IR.PRS200	1/2" x 1/2"	0,46	25	400	B
IR.PRS20C	3/4" x 1/2"	0,46	25	350	B
IR.PRS250	3/4" x 3/4"	0,49	25	300	B



PRR

PROLUNGA REGISTRABILE

CODICE	Ø	PREZZO (€)	CONF.	BOX	CAT.
IR.PRR20C	3/4 x 3/4 / 1/2	2,40	20	200	B

ACCESSORI



PF

PROLUNGA A SEGMENTI

CODICE	Ø	PREZZO (€)	CONF.	BOX	CAT.
RN.PF1	1/2" x 1/2"	0,70	25	400	A
RN.PF2	3/4" x 1/2"	0,80	25	300	A
RN.PF3	3/4" x 3/4"	0,70	25	250	A



GS

GIUNTO SNODATO

CODICE	Ø	PREZZO (€)	CONF.	BOX	CAT.
HU.GS3320	1"	37,57	-	30	B
HU.GS3500	1" 1/2	58,66	-	30	B



NASTRO TENUTA TEFLON

CODICE	Ø	PREZZO (€)	CONF.	BOX	CAT.
IR.NAS120	1/2"x12 mt	0,55	10	250	B
IR.NAS200	3/4"x12 mt	0,99	10	200	B
IR.NSP150	Professionale	3,96	1	63	B



VALVOLA DRENAGGIO OTTONE

CODICE	Ø	PREZZO (€)	CONF.	BOX	CAT.
RN.51039	1/2" M.	5,57	25	-	B



3M

CONNETTORE STAGNO

CODICE	DESCR.	PREZZO (€)	CONF.	BOX	CAT.
RN.CS-3M	3M-316	1,90	30	-	B



BVS

CONNETTORE STAGNO

CODICE	Ø	PREZZO (€)	CONF.	BOX	CAT.
HA.BVS1	0,5-1.3 mm	1,74	25	-	B
HA.BVS2	fino a 2,5 mm	2,70	25	-	B



CAVO ELETTRICO INTERRABILE

CODICE	CONDUTTORI	PREZZO (€)	CONF.	BOX	CAT.
MA.CM280	3	78,20	75 mt	-	B
MA.CM580	5	118,10	75 mt	-	B
MA.CM780	7	159,50	75 mt	-	B
MA.CM980	9	204,40	75 mt	-	B
MA.CM1380	13	274,60	75 mt	-	B



HCV

VALVOLA ANTI-GOCCIOLAMENTO

CODICE	Ø	PREZZO (€)	CONF.	BOX	CAT.
HA.HCV015	1/2"	8,05	1	-	B
HA.HCV020	3/4"	9,20	1	-	B



PNZ

PINZA TAGLIATUBO LAMA INOX

CODICE	Ø	PREZZO (€)	CONF.	BOX	CAT.
IR.PNZ320	16-64	34,00	1	-	A



CSE

CHIAVE SERRAGGIO GHIERE

CODICE	Ø	PREZZO (€)	CONF.	BOX	CAT.
IRCSE.300	25 - 63	28,50	1	-	A
IRCSE.750	25 - 110	34,50	1	-	A



172

VALVOLINA SCARICO COLLETTORE

CODICE	Ø	PREZZO (€)	CONF.	BOX	CAT.
TE172.200	1/2"	4,90	1	25	B



BAN

BANDIERINA SEGNALAZIONE

CODICE	Ø	PREZZO (€)	CONF.	BOX	CAT.
IR.BANBLU	blu	0,37	25	350	B
IR.BANROS	rossa	0,37	25	350	B
IR.BANGIA	gialla	0,37	25	350	B
IR.BANBIA	bianca	0,37	25	350	B

POZZETTI PER ELETTROVALVOLE



POZ

POZZETTO CIRCOLARE

CODICE	Ø	PREZZO (€)	CONF.	BOX	CAT.
IR.POZZ.0	Mini	5,40	1	468	A
IR.POZZ.1	Large	9,40	1	126	A



PVZ

POZZETTO POLYPROPYLENE

POZZETTO SUPERJUMBO

CODICE	Ø	PREZZO (€)	CONF.	BOX	CAT.
IR.PVZ.4	S-Jumbo	175,00	1	-	A



EST

ESTENSIONE PER POZZETTO 16,5 CM

ESTENSIONE PER POZZETTO

CODICE	Ø	PREZZO (€)	CONF.	BOX	CAT.
IR.PEST.04R	Standard	29,25	1	-	A
IR.PEST.06R	Jumbo	41,25	1	-	A



260

POZZETTO C/VALV.RACC.GIREVOLE

CODICE	Ø	PREZZO (€)	CONF.	BOX	CAT.
CO260	18	28,00	1	12	B



PZC

POZZETTO C/VALVOLA 3/4"

CODICE	Ø	PREZZO (€)	CONF.	BOX	CAT.
RN.PZC15	21	25,50	1	12	B



IDS

IDRANTINO IRRITEC

CODICE	Ø	PREZZO (€)	CONF.	BOX	CAT.
IR.IDS250	3/4"	8,67	1	50	A



CHS

CHIAVE PER IDRANTINO

CODICE	Ø	PREZZO (€)	CONF.	BOX	CAT.
IR.CHS250	3/4"	3,77	1	100	A



PCZ

COPERCHIO CON BORDO
CHIUSURA CON BULLONE

POZZETTO RETTANGOLARE

CODICE	Ø	PREZZO (€)	CONF.	BOX	CAT.
IR.PCZ.2	Standard	27,90	1	150	A
IR.PCZ.3	Jumbo	49,60	1	100	A

MISURE POZZETTI

CODICE	BASE INF.	BASE SUP.	ALTEZZA
IR.POZZ.0	200	160	230
IR.POZZ.1	320	225	250
IR.PCZ.2	380x496	273x405	300
IR.PCZ.3	500x650	370x520	300
IR.PVZ.4	590x831	406x647	381
IR.PVZ.5	457x1035	495x825	457

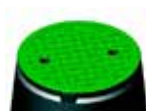

CPOZ

RICAMBIO

COPERCHIO PER POZZETTO

CODICE	TIPO	PREZZO (€)	CONF.	BOX	CAT.
IR.CPOZ.0	MINI	2,17	1	-	A
IR.CPOZ.1	LARGE	3,76	1	-	A
IR.CPCZ.2	STANDARD	12,39	1	-	A
IR.CPCZ.3	JUMBO	21,47	1	-	A

COLONNINE DA GIARDINO COLORTAP

VEDI L'ASSORTIMENTO COMPLETO A PAGINA 48



Long-Life
Metal System



407

COLONNINA TOTEM OVALE 120 CM

CODICE	DESCR.	PREZZO (€)	CONF.	BOX	CAT.
CO407	2 RUBINETTI	149,00	1	-	B



400

COLONNINA TRIANGOLARE 120 CM

CODICE	DESCR.	PREZZO (€)	CONF.	BOX	CAT.
CO400	2 RUBINETTI	139,00	1	-	B



409

COLONNINA LOOP 120 CM

CODICE	DESCR.	PREZZO (€)	CONF.	BOX	CAT.
CO409	1 RUBINETTO	99,00	1	-	B

COLLETTORI CON O-R E GHIERA LIBERA IRRITEC



431

TEE 2 GHIERE M/F/F

CODICE	Ø	PREZZO (€)	CONF.	BOX	CAT.
IR431.320	1"	4,22	50	100	A
IR431.500	1"½	9,48	5	60	A
IR431.630	2"	13,23	5	40	A



433

CROCE M/F/F/F

CODICE	Ø	PREZZO (€)	CONF.	BOX	CAT.
IR433.320	1"	7,12	50	100	A
IR433.500	1"½	13,09	5	25	A
IR433.630	2"	19,39	5	15	A



435

COLLETTORE 3 USCITE

CODICE	Ø	PREZZO (€)	CONF.	BOX	CAT.
IR435.320	1"	22,50	50	150	A



426

GOMITO F/F

CODICE	Ø	PREZZO (€)	CONF.	BOX	CAT.
IR426.320	1"	3,89	50	150	A
IR426.500	1"½	8,61	5	95	A
IR426.630	2"	12,27	5	50	A



420

MANICOTTO F/F

CODICE	Ø	PREZZO (€)	CONF.	BOX	CAT.
IR420.320	1"	3,00	50	150	A



407

NIPPLLO

CODICE	Ø	PREZZO (€)	CONF.	BOX	CAT.
IR407.320	1"	1,28	10	300	A
IR407.500	1"½	3,45	10	240	A
IR407.630	2"	5,25	10	160	A



425

RACCORDO CON GHIERA LIBERA

CODICE	Ø	PREZZO (€)	CONF.	BOX	CAT.
IR425.32C	1" x 25	2,61	10	160	A
IR425.32D	1" x 32	2,96	10	160	A



432

TEE 1 GHIERA M/M/F

CODICE	Ø	PREZZO (€)	CONF.	BOX	CAT.
IR432.320	1"	3,17	50	100	A



434

COLLETTORE 2 USCITE

CODICE	Ø	PREZZO (€)	CONF.	BOX	CAT.
IR434.320	1"	15,90	50	150	A



436

COLLETTORE 4 USCITE

CODICE	Ø	PREZZO (€)	CONF.	BOX	CAT.
IR436.320	1"	29,40	50	150	A



427

GOMITO M/F

CODICE	Ø	PREZZO (€)	CONF.	BOX	CAT.
IR427.320	1"	3,03	50	150	A
IR427.500	1"½	6,71	5	90	A
IR427.630	2"	10,86	5	70	A



424

MANICOTTO M/F

CODICE	Ø	PREZZO (€)	CONF.	BOX	CAT.
IR424.320	1"	2,31	50	250	A
IR424.500	1"½	5,31	5	170	A
IR424.630	2"	7,92	5	120	A



419

NIPPLLO RIDOTTO

CODICE	Ø	PREZZO (€)	CONF.	BOX	CAT.
IR419.32C	1" x 3/4"	1,32	50	300	A
IR419.50E	1"½ x 1"¼	3,80	10	300	A
IR419.63F	2" x 1"½	5,63	10	200	A



428

GOMITO CON GHIERA LIBERA

CODICE	Ø	PREZZO (€)	CONF.	BOX	CAT.
IR428.32C	1" x 25	3,36	10	200	A
IR428.32D	1" x 32	4,08	10	140	A

COLLETTORI IN OTTONE CON GHIERA LIBERA COLORTAP



CON GUARNIZIONE PIANA

TEE 2 GHIERE M/F/F

CODICE	Ø	PREZZO (€)	CONF.	BOX	CAT.
C0241	¾"	13,05	12	-	B
C0211	1"	17,37	12	-	B
C0231	1½"	59,12	6	-	B



CON GUARNIZIONE PIANA

DOPPIO TEE 3 GHIERE

CODICE	Ø	PREZZO (€)	CONF.	BOX	CAT.
C0242	¾"	24,37	6	-	B
C0212	1"	32,45	6	-	B



CON GUARNIZIONE PIANA

GOMITO 1 GHIERA

CODICE	Ø	PREZZO (€)	CONF.	BOX	CAT.
C0243	¾"	9,57	12	-	B
C0213	1"	12,79	12	-	B
C0233	1½"	38,22	6	-	B



CON GUARNIZIONE PIANA

GOMITO 2 GHIERE

CODICE	Ø	PREZZO (€)	CONF.	BOX	CAT.
C0244	¾"	11,28	12	-	B
C0214	1"	15,08	12	-	B
C0234	1½"	46,38	6	-	B



CON GUARNIZIONE PIANA

CROCE 3 GHIERE

CODICE	Ø	PREZZO (€)	CONF.	BOX	CAT.
C0240	¾"	21,48	6	-	B
C0210	1"	29,02	6	-	B



CON GUARNIZIONE PIANA

MANICOTTO 1 GHIERA

CODICE	Ø	PREZZO (€)	CONF.	BOX	CAT.
C0245	¾"	7,80	25	-	B
C0215	1"	10,50	25	-	B
C0235	1½"	32,49	12	-	B



CON GUARNIZIONE PIANA

MANICOTTO 2 GHIERE

CODICE	Ø	PREZZO (€)	CONF.	BOX	CAT.
C0246	¾"	8,74	25	-	B
C0216	1"	11,60	25	-	B
C0236	1½"	38,22	12	-	B



NEW

211V

TEE CON VALVOLE

CODICE	Ø	PREZZO (€)	CONF.	BOX	CAT.
C0211V	1"	25,48	12	-	B



NEW

212V

DOPPIO TEE C/VALVOLE

CODICE	Ø	PREZZO (€)	CONF.	BOX	CAT.
C0212V	1"	46,38	6	-	B



NEW

213V

GOMITO 1 GHIERA CON VALVOLE

CODICE	Ø	PREZZO (€)	CONF.	BOX	CAT.
C0213V	1"	19,70	12	-	B



CON GUARNIZIONE PIANA

VALVOLE A SFERA CON GHIERA

CODICE	Ø	PREZZO (€)	CONF.	BOX	CAT.
C0225	1" M/F	17,37	6	-	B
C0226	1" F/F	17,37	6	-	B



CON GUARNIZIONE PIANA

TAPPO

CODICE	Ø	PREZZO (€)	CONF.	BOX	CAT.
C0248	¾"	3,48	25	-	B
C0218	1"	3,48	25	-	B
C0238	1½"	11,60	25	-	B



CON GUARNIZIONE PIANA

TAPPO CON SCARICO

CODICE	Ø	PREZZO (€)	CONF.	BOX	CAT.
C0249	¾" foro ½"	4,68	25	-	B
C0219	1" foro ½"	4,68	25	-	B
C0239	1½" foro ¾"	12,79	25	-	B



NIPPOLO CON O-R

CODICE	Ø	PREZZO (€)	CONF.	BOX	CAT.
C0222	¾" x ¾"	4,37	25	-	B
C0220	1" x 1"	4,89	25	-	B
C0221	1" x ¾"	4,89	25	-	B

TUBO POLIETILENE PER IRRIGAZIONE



BASSA DENSITA' PN 4

CODICE	Ø	PREZZO (€)	CONF.	PN	CAT.
TP.16.04.BD	16	0,37	500	4	BV
TP.20.04.BD	20	0,54	200	4	BV
TP.25.04.BD	25	0,68	200	4	BV
TP.32.04.BD	32	0,96	100	4	BV
TP.40.04.BD	40	1,39	100	4	BV

BASSA DENSITA' PN 6

CODICE	Ø	PREZZO (€)	CONF.	PN	CAT.
TP.16.06.BD	16	0,42	500	6	BV
TP.20.06.BD	20	0,56	200	6	BV
TP.25.06.BD	25	0,85	200	6	BV
TP.32.06.BD	32	1,38	100	6	BV
TP.40.06.BD	40	2,12	100	6	BV
TP.50.06.BD	50	3,23	100	6	BV
TP.63.06.BD	63	5,08	100	6	BV

ALTA DENSITA' PE100 PN 10

CODICE	Ø	PREZZO (€)	CONF.	PN	CAT.
TP.20.10.HD	20	0,57	200	10	BV
TP.25.10.HD	25	0,69	100	10	BV
TP.32.10.HD	32	1,08	100	10	BV
TP.40.10.HD	40	1,64	100	10	BV
TP.50.10.HD	50	2,36	100	10	BV
TP.63.10.HD	63	3,77	100	10	BV

BOBINE RIDOTTE GARDEN



POLIETILENE BASSA DENSITA' PN 6

CODICE	Ø	PREZZO (€)	MT	PN	CAT.
SP.R016.25	16	9,70	25	6	B
SP.R016.50	16	19,02	50	6	B
SP.R016.100	16	36,36	100	6	B
SP.R020.50	20	28,32	50	6	B
SP.R020.100	20	56,40	100	6	B
SP.R025.25	25	23,10	25	6	B
SP.R025.50	25	46,20	25	6	B
SP.R032.50	32	59,46	50	6	B



POLIETILENE BASSA DENSITA' PN 4

CODICE	Ø	PREZZO (€)	MT	PN	CAT.
SP.R016.104	16	27,6	100	4	B
SP.R020.104	20	37,2	100	4	B
SP.R025.104	25	59,2	100	4	B

PRESE A STAFFA



103

PRESA STAFFA 2 BULLONI

CODICE	Ø	PREZZO (€)	BULLONI	BOX	CAT.
IR103.20B	20x1/2"	1,28	2	200	A
IR103.25B	25x1/2"	1,28	2	130	A
IR103.25C	25x3/4"	1,28	2	130	A
IR103.32B	32x1/2"	1,59	2	90	A
IR103.32C	32x3/4"	1,59	2	90	A
IR103.32D	32x1"	1,78	2	90	A
IR103.40B	40x1/2"	1,88	2	70	A
IR103.40C	40x3/4"	1,88	2	70	A
IR103.40D	40x1"	1,88	2	70	A
IR103.50B	50x1/2"	1,96	2	60	A
IR103.50C	50x3/4"	1,96	2	60	A
IR103.50D	50x1"	1,96	2	60	A
IR103.63B	63x1/2"	2,75	4	35	A
IR103.63C	63x3/4"	2,75	4	35	A
IR103.63D	63x1"	2,75	4	35	A
IR103.63E	63x1 1/4"	3,00	4	35	A
IR103.75C	75x3/4"	4,79	4	50	A
IR103.75D	75x1"	4,79	4	50	A
IR103.75E	75 x 1 1/4"	5,08	4	50	A
IR103.90C	90 x 3/4"	6,18	4	40	A
IR103.90D	90 x 1"	6,18	4	40	A
IR103.110D	110x1"	7,43	4	35	A
IR103.110F	110x1 1/2"	7,43	4	35	A
IR103.110G	110x2"	7,98	4	35	A
IR103.125G	125x2"	21,56	4	30	A



ST1

STAFFA FISSAGGIO A MURO

CODICE	Ø	PREZZO (€)	CONF.	BOX	CAT.
ASST1.160	16	0,35	10	-	A
ASST1.200	20	0,39	10	-	A
ASST1.250	25	0,45	10	-	A
ASST1.320	32	0,52	10	-	A
ASST1.400	40	0,78	10	-	A
ASST1.500	50	1,23	10	-	A
ASST1.630	63	1,62	10	-	A
ASST1.750	75	14,58	10	-	A



GRG

GANCIO DI SOSTEGNO

CODICE	Ø	PREZZO (€)	CONF.	BOX	CAT.
IR.GRG160	16	0,049	500	6000	A
IR.GRG200	20	0,079	200	4000	A
IR.GRG250	25	0,163	200	2000	A
IR.GRG320	32	0,207	100	1000	A



210

MANICOTTO

CODICE	Ø	PREZZO (€)	CONF.	BOX	CAT.
IR210.160	16	1,66	20	160	A
IR210.200	20	2,16	20	160	A
IR210.250	25	2,75	10	200	A
IR210.320	32	3,53	10	120	A
IR210.400	40	5,78	5	70	A
IR210.500	50	7,88	5	40	A
IR210.630	63	10,91	5	25	A
IR210.750	75	21,77	1	-	A
IR210.900	90	27,33	1	-	A



212

MANICOTTO RIDOTTO

CODICE	Ø	PREZZO (€)	CONF.	BOX	CAT.
IR212.20A	20x16	2,28	10	160	A
IR212.25A	25x16	2,48	10	240	A
IR212.25B	25x20	2,48	10	240	A
IR212.32B	32x20	3,26	10	140	A
IR212.32C	32x25	3,26	10	140	A
IR212.40D	40x32	5,62	5	90	A
IR212.50E	50x40	7,28	5	55	A
IR212.63F	63x50	10,30	5	30	A
IR212.75G	75x63	19,80	1	-	A



213

GOMITO A 90°

CODICE	Ø	PREZZO (€)	CONF.	BOX	CAT.
IR213.160	16	1,81	20	140	A
IR213.200	20	2,28	20	140	A
IR213.250	25	2,79	10	180	A
IR213.320	32	3,48	10	100	A
IR213.400	40	6,14	5	60	A
IR213.500	50	8,50	5	35	A
IR213.630	63	10,88	5	25	A
IR213.750	75	22,58	1	-	A



214

TEA A 90°

CODICE	Ø	PREZZO (€)	CONF.	BOX	CAT.
IR214.160	16x16x16	2,21	20	80	A
IR214.200	20x20x20	3,00	20	80	A
IR214.250	25x25x25	3,98	10	100	A
IR214.320	32x32x32	5,15	10	60	A
IR214.400	40x40x40	8,50	5	40	A
IR214.500	50x50x50	11,58	5	30	A
IR214.630	63x63x63	16,54	5	12	A
IR214.750	75x75x75	30,91	1	-	A



221

TAPPO

CODICE	Ø	PREZZO (€)	CONF.	BOX	CAT.
IR221.160	16	1,23	20	300	A
IR221.200	20	1,56	20	300	A
IR221.250	25	1,72	10	400	A
IR221.320	32	2,12	10	240	A
IR221.400	40	3,56	5	130	A
IR221.500	50	5,25	5	80	A
IR221.630	63	7,11	5	45	A
IR221.750	75	19,32	1	-	A
IR221.900	90	21,59	1	-	A



224

T A 90° RIDOTTO

CODICE	Ø	PREZZO (€)	CONF.	BOX	CAT.
IR224.20A	20x16x20	3,53	20	80	A
IR224.20C	20x25x20	4,09	10	120	A
IR224.25B	25x20x25	4,09	10	110	A
IR224.25D	25x32x25	5,47	10	100	A
IR224.32C	32x25x32	5,47	5	60	A
IR224.40D	40x32x40	7,60	5	70	A
IR224.50E	50x40x50	10,42	5	60	A
IR224.63F	63x50x63	13,61	5	45	A



425

RACCORDO CON GHIERA LIBERA

CODICE	Ø	PREZZO (€)	CONF.	BOX	CAT.
IR425.32C	1"x25	2,61	10	160	A
IR425.32D	1"x32	2,96	10	160	A



428

GOMITO CON GHIERA LIBERA

CODICE	Ø	PREZZO (€)	CONF.	BOX	CAT.
IR428.32C	1"x25	3,36	10	200	A
IR428.32D	1"x32	4,08	10	140	A



201

RACCORDO FEMMINA

CODICE	Ø	PREZZO (€)	CONF.	BOX	CAT.
IR201.16B	16x1/2"	1,09	20	240	A
IR201.16C	16x3/4"	1,09	20	200	A
IR201.20B	20x1/2"	1,44	20	240	A
IR201.20C	20x3/4"	1,44	20	180	A
IR201.25B	25x1/2"	1,66	10	300	A
IR201.25C	25x3/4"	1,66	10	300	A
IR201.25D	25x1"	1,66	10	300	A
IR201.32C	32x3/4"	2,13	10	200	A
IR201.32D	32x1"	2,13	10	200	A
IR201.32E	32x1 1/4"	2,95	10	160	A
IR201.40D	40x1"	3,65	5	100	A
IR201.40E	40x1 1/4"	3,65	5	100	A
IR201.40F	40x1 1/2"	3,79	5	100	A
IR201.50E	50x1 1/4"	4,73	5	65	A
IR201.50F	50x1 1/2"	4,73	5	65	A
IR201.50G	50x2"	5,07	5	60	A
IR201.63F	63x1 1/2"	6,72	5	35	A
IR201.63G	63x2"	6,72	5	35	A
IR201.75H	75x2 1/2"	14,23	1	-	A
IR201.90I	90x3"	17,67	1	-	A



211

RACCORDO MASCHIO

CODICE	Ø	PREZZO (€)	CONF.	BOX	CAT.
IR211.16B	16x1/2"	1,12	20	240	A
IR211.16C	16x3/4"	1,12	20	240	A
IR211.20B	20x1/2"	1,32	20	240	A
IR211.20C	20x3/4"	1,32	20	240	A
IR211.25B	25x1/2"	1,53	10	290	A
IR211.25C	25x3/4"	1,53	10	300	A
IR211.25D	25x1"	1,53	10	300	A
IR211.32C	32x3/4"	1,93	10	180	A
IR211.32D	32x1"	1,93	10	180	A
IR211.32E	32x1 1/4"	2,16	10	180	A
IR211.40D	40x1"	3,59	5	100	A
IR211.40E	40x1 1/4"	3,59	5	100	A
IR211.40F	40x1 1/2"	3,59	5	100	A
IR211.50F	50x1 1/2"	4,82	5	70	A
IR211.50G	50x2"	4,91	5	60	A
IR211.63F	63x1 1/2"	6,66	5	35	A
IR211.63G	63x2"	6,66	5	40	A
IR211.63H	63x2 1/2"	6,66	5	35	A
IR211.75G	75x2"	14,08	1	-	A
IR211.75H	75x2 1/2"	14,08	1	-	A
IR211.90I	90x3"	16,68	1	-	A



218

GOMITO A 90° FEMMINA

CODICE	Ø	PREZZO (€)	CONF.	BOX	CAT.
IR218.16B	16x1/2"	1,40	20	160	A
IR218.16C	16x3/4"	1,40	20	160	A
IR218.20B	20x1/2"	1,72	20	160	A
IR218.20C	20x3/4"	1,72	20	160	A
IR218.25B	25x1/2"	2,16	10	250	A
IR218.25C	25x3/4"	2,16	10	240	A
IR218.25D	25x1"	2,16	10	200	A
IR218.32B	32x1/2"	2,53	10	160	A
IR218.32C	32x3/4"	2,53	10	160	A
IR218.32D	32x1"	2,53	10	160	A
IR218.40C	40x3/4"	5,00	5	80	A
IR218.40D	40x1"	5,00	5	80	A
IR218.40E	40x1 1/4"	5,00	5	80	A
IR218.40F	40x1 1/2"	5,00	5	80	A
IR218.50F	50x1 1/2"	6,67	5	50	A
IR218.63G	63x2"	9,17	5	20	A
IR218.75H	75x2 1/2"	17,51	1	-	A



219

GOMITO A 90° MASCHIO

CODICE	Ø	PREZZO (€)	CONF.	BOX	CAT.
IR219.16B	16x1/2"	1,46	20	240	A
IR219.16C	16x3/4"	1,46	20	240	A
IR219.20B	20x1/2"	1,54	20	240	A
IR219.20C	20x3/4"	1,54	20	240	A
IR219.25B	25x1/2"	1,87	10	250	A
IR219.25C	25x3/4"	1,87	10	250	A
IR219.25D	25x1"	1,87	10	240	A
IR219.32C	32x3/4"	2,41	10	160	A
IR219.32D	32x1"	2,41	10	160	A
IR219.40D	40x1"	3,84	5	80	A
IR219.40E	40x1 1/4"	3,84	5	80	A
IR219.50F	50x1 1/2"	5,23	5	50	A
IR219.63G	63x2"	7,29	5	25	A



215

TEE A 90° FILETTATO FEMMINA

CODICE	Ø	PREZZO (€)	CONF.	BOX	CAT.
IR215.16B	16x1/2"x16	1,90	20	100	A
IR215.16C	16x3/4"x16	1,90	20	100	A
IR215.20B	20x1/2"x20	2,41	20	100	A
IR215.20C	20x3/4"x20	2,41	20	100	A
IR215.25B	25x1/2"x25	3,06	10	150	A
IR215.25C	25x3/4"x25	3,06	10	130	A
IR215.25D	25x1"x25	3,40	10	130	A
IR215.32C	32x3/4"x32	3,98	10	80	A
IR215.32D	32x1"x32	3,98	10	80	A
IR215.32E	32x1"x32	4,07	10	60	A
IR215.40D	40x1"x40	7,29	5	50	A
IR215.40E	40x1"x40	7,29	5	45	A
IR215.40F	40x1"x40	7,29	5	45	A
IR215.50E	50x1"x50	9,89	5	25	A
IR215.50F	50x1"x50	9,89	5	25	A
IR215.50G	50x2"x50	10,47	5	25	A
IR215.63F	63x1"x63	14,55	5	12	A
IR215.63G	63x2"x63	14,55	5	12	A
IR215.75H	72x2"x75	26,18	1	-	A



216

TEE A 90° FILETTATO MASCHIO

CODICE	Ø	PREZZO (€)	CONF.	BOX	CAT.
IR216.16B	16x1/2"x16	2,43	20	100	A
IR216.16C	16x3/4"x16	2,43	20	100	A
IR216.20B	20x1/2"x20	2,53	20	100	A
IR216.20C	20x3/4"x20	2,53	20	100	A
IR216.25B	25x1/2"x25	3,31	10	160	A
IR216.25C	25x3/4"x25	3,31	10	120	A
IR216.25D	25x1"x25	3,31	10	120	A
IR216.32C	32x3/4"x32	4,15	10	80	A
IR216.32D	32x1"x32	4,15	10	80	A
IR216.40E	40x1"x40	7,28	5	50	A
IR216.50F	50x1"x50	10,30	5	35	A
IR216.63G	63x2"x63	20,12	4	16	A
IR216.75H	72x2"x75	26,34	1	-	A



222

GOMITO CON DERIVAZIONE

CODICE	Ø	PREZZO (€)	CONF.	BOX	CAT.
IR222.25B	1/2"x25x25	3,56	10	160	A
IR222.32C	3/4"x32x32	4,34	10	100	A



223

PLACCA MURALE

CODICE	Ø	PREZZO (€)	CONF.	BOX	CAT.
IR223.25C	25x3/4"	5,28	10	100	A

RICAMBI



2AG

ANELLO DI GRAFFAGGIO

CODICE	Ø	PREZZO (€)	CONF.	BOX	CAT.
IR2-AG16	16	0,29	1	-	A
IR2-AG20	20	0,41	1	-	A
IR2-AG25	25	0,48	1	-	A
IR2-AG32	32	0,61	1	-	A
IR2-AG40	40	1,00	1	-	A
IR2-AG50	50	1,36	1	-	A
IR2-AG63	63	1,90	1	-	A
IR2-AG75	75	3,33	1	-	A



2GH

GHIERA

CODICE	Ø	PREZZO (€)	CONF.	BOX	CAT.
IR2-GH16	16	0,44	1	-	A
IR2-GH20	20	0,63	1	-	A
IR2-GH25	25	0,75	1	-	A
IR2-GH32	32	0,99	1	-	A
IR2-GH40	40	1,60	1	-	A
IR2-GH50	50	2,14	1	-	A
IR2-GH63	63	3,01	1	-	A



2OR

GUARNIZIONE

CODICE	Ø	PREZZO (€)	CONF.	BOX	CAT.
IR2-OR16	16	0,27	10	-	A
IR2-OR20	20	0,36	10	-	A
IR2-OR25	25	0,44	10	-	A
IR2-OR32	32	0,56	10	-	A
IR2-OR40	40	0,94	10	-	A
IR2-OR50	50	1,26	10	-	A
IR2-OR63	63	1,75	10	-	A
IR2-OR75	75	3,09	5	-	A



2DS

BUSSOLA DI BLOCCAGGIO

CODICE	Ø	PREZZO (€)	CONF.	BOX	CAT.
IR2-DS16	16	0,26	10	-	A
IR2-DS20	20	0,34	10	-	A
IR2-DS25	25	0,41	10	-	A
IR2-DS32	32	0,53	10	-	A
IR2-DS40	40	0,85	10	-	A
IR2-DS50	50	1,16	10	-	A
IR2-DS63	63	1,62	10	-	A
IR2-DS75	75	3,06	5	-	A



301

F/F CON GHIERA

CODICE	Ø	PREZZO (€)	CONF.	BOX	CAT.
AS301.200	1/2"	15,26	1	120	A
AS301.250	3/4"	13,51	1	80	A
AS301.320	1"	15,40	1	60	A
AS301.400	1 1/4"	17,57	1	30	A
AS301.500	1 1/2"	27,02	1	20	A
AS301.630	2"	35,28	1	10	A



303

M/F CON GHIERA

CODICE	Ø	PREZZO (€)	CONF.	BOX	CAT.
AS303.200	1/2"	14,21	1	120	A
AS303.250	3/4"	14,98	1	80	A
AS303.320	1"	16,10	1	60	A
AS303.400	1 1/4"	18,73	1	30	A
AS303.500	1 1/2"	27,30	1	20	A
AS303.630	2"	32,90	1	10	A



305

GHIERA E GIUNTO PER POLIETILENE

CODICE	Ø	PREZZO (€)	CONF.	BOX	CAT.
AS305.200	1/2"x20	12,88	1	100	A
AS305.250	3/4"x25	14,45	1	60	A
AS305.320	1"x32	15,65	1	40	A



325

F/F DOPPIA GHIERA

CODICE	Ø	PREZZO (€)	CONF.	BOX	CAT.
AS325.250	3/4"	13,58	1	30	A
AS325.320	1"	18,20	1	50	A
AS325.400	1 1/4"	20,58	1	30	A
AS325.500	1 1/2"	31,36	1	20	A
AS325.630	2"	40,18	1	12	A



3MF

M/F CON GHIERA

CODICE	Ø	PREZZO (€)	CONF.	BOX	CAT.
IR3MF.250	3/4"	3,64	1	60	A
IR3MF.320	1"	3,64	1	60	A
IR3MF.400	1 1/4"	9,75	1	40	A
IR3MF.500	1 1/2"	11,57	1	25	A
IR3MF.630	2"	17,29	1	13	A



3FF

F/F CON GHIERA

CODICE	Ø	PREZZO (€)	CONF.	BOX	CAT.
IR3FF.250	3/4"	3,51	1	60	A
IR3FF.320	1"	3,51	1	60	A
IR3FF.400	1 1/4"	10,14	1	40	A
IR3FF.500	1 1/2"	12,22	1	25	A
IR3FF.630	2"	17,81	1	13	A

VALVOLE A SFERA IN METALLO



231

F/F CON LEVA

CODICE	Ø	PREZZO (€)	CONF.	BOX	CAT.
TE231.200	1/2"	6,35	15	135	B
TE231.250	3/4"	8,85	10	90	B
TE231.320	1"	13,17	10	60	B
TE231.400	1 1/4"	24,96	6	36	B
TE231.500	1 1/2"	35,55	4	16	B
TE231.630	2"	56,48	6	12	B



232

F/F CON FARFALLA

CODICE	Ø	PREZZO (€)	CONF.	BOX	CAT.
TE232.200	1/2"	6,35	20	180	B
TE232.250	3/4"	8,85	12	108	B
TE232.320	1"	13,17	10	60	B



233

M/F CON LEVA

CODICE	Ø	PREZZO (€)	CONF.	BOX	CAT.
TE233.200	1/2"	6,60	15	135	B
TE233.250	3/4"	9,05	10	90	B
TE233.320	1"	13,40	10	60	B



234

M/F CON FARFALLA

CODICE	Ø	PREZZO (€)	CONF.	BOX	CAT.
TE234.200	1/2"	6,60	20	-	B
TE234.250	3/4"	9,05	12	-	B
TE234.320	1"	13,40	10	-	B



607

NIPLO

CODICE	Ø	PREZZO (€)	CONF.	BOX	CAT.
IR607.200	1/2"	0,22	20	-	A
IR607.250	3/4"	0,27	20	-	A
IR607.320	1"	0,38	20	-	A
IR607.400	1"1/4	0,68	50	-	A
IR607.500	1"1/2	0,81	20	-	A
IR607.630	2"	1,46	10	-	A
IR607.750	2"1/2	2,81	10	-	A
IR607.900	3"	3,64	5	-	A



619

NIPLO RIDOTTO

CODICE	Ø	PREZZO (€)	CONF.	BOX	CAT.
IR619.25B	3/4"x1/2"	0,26	20	-	A
IR619.32B	1"x1/2"	0,35	50	-	A
IR619.32C	1"x3/4"	0,35	20	-	A
IR619.40C	1"1/4x3/4"	0,60	50	-	A
IR619.40D	1"1/4x1"	0,60	50	-	A
IR619.50D	1"1/2x1"	0,81	20	-	A
IR619.50E	1"1/4x1"1/2	0,81	20	-	A
IR619.63E	2"x1"1/4	1,39	10	-	A
IR619.63F	2 x1"1/2	1,39	10	-	A
IR619.75G	2"1/2x2"	4,30	10	-	A
IR619.90G	3x2"1/2	4,80	1	-	A



623

BUSSOLA RIDUZIONE

CODICE	Ø	PREZZO (€)	CONF.	BOX	CAT.
IR623.25B	3/4"x1/2"	0,51	20	-	A
IR623.32B	1"x1/2"	0,55	50	-	A
IR623.32C	1"x3/4"	0,56	20	-	A
IR623.40B	1"1/4x1/2"	0,94	50	-	A
IR623.40C	1"1/4x3/4"	0,94	50	-	A
IR623.40D	1"1/4x1"	0,94	50	-	A
IR623.50C	1"1/2x3/4"	1,18	20	-	A
IR623.50D	1"1/2x1"	1,18	20	-	A
IR623.50E	1"1/2x1"1/4	1,18	20	-	A
IR623.63C	2"x3/4"	2,32	10	-	A
IR623.63D	2"x1"	2,32	10	-	A
IR623.63E	2"x1"1/4	2,32	10	-	A
IR623.63F	2"x1"1/2	2,70	10	-	A
IR623.75G	2"1/2x2"	4,56	1	-	A
IR623.90G	3" x 2"	6,29	1	-	A
IR623.90H	3" x 2"1/2	6,29	1	-	A



625

MAGGIORATORE

CODICE	Ø	PREZZO (€)	CONF.	BOX	CAT.
IR625.20C	3/4"x1/2"	1,09	20	-	A
IR625.20D	1/2"x1"	1,31	50	-	A
IR625.25D	1"x3/4"	1,31	10	-	A
IR625.32E	1"1/4x1"	1,87	25	-	A
IR625.32F	1"x1"1/2	2,07	20	-	A
IR625.32G	1"x2"	2,65	10	-	A
IR625.40F	1"1/2 x1"1/4	2,56	20	-	A
IR625.50G	1" 1/2"x2"	2,81	10	-	A



620

MANICOTTO

CODICE	Ø	PREZZO (€)	CONF.	BOX	CAT.
IR620.200	1/2"	0,51	10	-	A
IR620.250	3/4"	0,55	10	-	A
IR620.320	1"	0,74	50	-	A
IR620.400	1" 1/4	1,98	50	-	A
IR620.500	1" 1/2	2,58	20	-	A
IR620.630	2"	3,47	20	-	A
IR620.900	3"	12,73	1	-	A



621

MANICOTTO RIDOTTO

CODICE	Ø	PREZZO (€)	CONF.	BOX	CAT.
IR621.25B	3/4"x1/2"	0,58	20	-	A
IR621.32C	1"x3/4"	0,75	10	-	A
IR621.40D	1"1/4x1"	1,65	25	-	A
IR621.50E	1"1/2x1"1/4	2,51	20	-	A
IR621.63F	1"1/2x2"	3,31	10	-	A



626

GOMITO FEMMINA

CODICE	Ø	PREZZO (€)	CONF.	BOX	CAT.
IR626.200	1/2"	0,98	20	-	A
IR626.250	3/4"	1,16	10	-	A
IR626.320	1"	1,42	10	-	A
IR626.400	1" 1/4	2,53	10	-	A
IR626.500	1" 1/2	4,80	10	-	A
IR626.630	2"	6,62	10	-	A
IR626.900	3"	21,50	1	-	A



627

GOMITO MASCHIO/FEMMINA

CODICE	Ø	PREZZO (€)	CONF.	BOX	CAT.
IR627.200	1/2"	0,69	10	-	A
IR627.250	3/4"	0,88	50	-	A
IR627.320	1"	1,06	25	-	A



630

TEE FEMMINA

CODICE	Ø	PREZZO (€)	CONF.	BOX	CAT.
IR630.200	1/2"	1,39	20	-	A
IR630.250	3/4"	1,59	20	-	A
IR630.320	1"	1,90	10	-	A
IR630.400	1" 1/4	3,31	10	-	A
IR630.500	1" 1/2	6,12	10	-	A
IR630.630	2"	8,76	5	-	A
IR630.900	3"	32,74	1	-	A



605

TEE MASCHIO

CODICE	Ø	PREZZO (€)	CONF.	BOX	CAT.
IR605.200	1/2"	0,79	10	-	A
IR605.250	3/4"	0,83	10	-	A
IR605.320	1"	1,22	10	-	A



609

CALOTTA

CODICE	Ø	PREZZO (€)	CONF.	BOX	CAT.
IR609.200	1/2"	0,22	20	-	A
IR609.250	3/4"	0,30	20	-	A
IR609.320	1"	0,32	50	-	A
IR609.400	1" 1/4	0,53	50	-	A
IR609.500	1" 1/2	1,22	20	-	A
IR609.630	2"	1,48	10	-	A
IR609.750	2" 1/2	5,71	1	-	A
IR609.900	3"	7,77	1	-	A



610

TAPPO

CODICE	Ø	PREZZO (€)	CONF.	BOX	CAT.
IR610.200	1/2"	0,30	10	-	A
IR610.250	3/4"	0,33	10	-	A
IR610.320	1"	0,42	50	-	A
IR610.400	1" 1/4	0,69	50	-	A
IR610.500	1" 1/2	0,86	20	-	A
IR610.630	2"	1,26	20	-	A



FSP

RACCORDO SERBATOIO PALLETIZZATO

CODICE	Ø	PREZZO (€)	CONF.	BOX	CAT.
IR.FSP320	1"	18,19	1	75	A
IR.FSP400	1" 1/4	19,02	1	75	A



B02

BOCCHETTONE PVC F/F

CODICE	Ø	PREZZO (€)	CONF.	BOX	CAT.
ASB02.250	3/4"	5,00	10	-	A
ASB02.320	1"	5,47	10	-	A
ASB02.400	1" 1/4	6,08	10	-	A
ASB02.500	1" 1/2	7,97	10	-	A
ASB02.630	2"	10,95	10	-	A

RACCORDI IN OTTONE PER POLIETILENE



4301

RACCORDO MASCHIO

CODICE	Ø	PREZZO (€)	CONF.	BOX	CAT.
TE4303.25B	25x1/2"	5,60	15	-	B
TE4301.25C	25x3/4"	5,28	15	-	B
TE4303.32C	32x3/4"	8,58	20	-	B
TE4301.32D	32x1"	7,73	20	-	B



4304

RACCORDO FEMMINA

CODICE	Ø	PREZZO (€)	CONF.	BOX	CAT.
TE4304.25B	25x1/2"	5,64	15	-	B
TE4302.25C	25x3/4"	5,39	15	-	B
TE4304.32C	32x3/4"	8,75	20	-	B
TE4302.32D	32x1"	7,73	20	-	B



4305

MANICOTTO

CODICE	Ø	PREZZO (€)	CONF.	BOX	CAT.
TE4305.250	25	9,60	12	-	B
TE4305.320	32	14,30	12	-	B



4307

TEE

CODICE	Ø	PREZZO (€)	CONF.	BOX	CAT.
TE4307.250	25	14,58	10	-	B
TE4307.320	32	20,81	6	-	B



4308

GOMITO

CODICE	Ø	PREZZO (€)	CONF.	BOX	CAT.
TE4308.250	25	10,20	12	-	B
TE4308.320	32	15,57	10	-	B



4306

TEE FILETTATO FEMMINA

CODICE	Ø	PREZZO (€)	CONF.	BOX	CAT.
TE4306.25C	25x3/4"	11,19	10	-	B
TE4306.32D	32x1"	16,52	10	-	B



4309

GOMITO MASCHIO

CODICE	Ø	PREZZO (€)	CONF.	BOX	CAT.
TE4309.25B	25x1/2"	7,32	10	-	B
TE4309.25C	25x3/4"	6,96	10	-	B
TE4309.32D	32x1"	10,64	10	-	B



4310

GOMITO FEMMINA

CODICE	Ø	PREZZO (€)	CONF.	BOX	CAT.
TE4310.25B	25x1/2"	7,32	10	-	B
TE4310.25C	25x3/4"	7,26	10	-	B
TE4310.32C	32x3/4"	11,70	10	-	B
TE4310.32D	32x1"	11,25	10	-	B



500

VALVOLA EUROPA

CODICE	Ø	PREZZO (€)	CONF.	BOX	CAT.
TE500.250	3/4"	11,73	8	-	C
TE500.320	1"	16,04	6	-	C
TE500.400	1 1/4"	25,10	4	-	C
TE500.500	1 1/2"	33,57	4	-	C



505

VALVOLA DI FONDO

CODICE	Ø	PREZZO (€)	CONF.	BOX	CAT.
TE505.250	3/4"	13,62	6	-	C
TE505.320	1"	17,87	4	-	C
TE505.400	1 1/4"	27,72	4	-	C
TE505.500	1 1/2"	36,83	2	-	C



155

IDRANTE

CODICE	Ø	PREZZO (€)	CONF.	BOX	CAT.
TE155.200	1/2"	11,73	10	72	B
TE155.250	3/4"	15,45	10	60	B
TE155.320	1"	21,96	5	30	B



151

RUBINETTO CURVO

CODICE	Ø	PREZZO (€)	CONF.	BOX	CAT.
TE151.200	1/2"	10,58	12	72	B
TE151.250	3/4"	13,65	8	48	B
TE151.320	1"	21,75	8	32	B



108S

NIPPLO

CODICE	Ø	PREZZO (€)	CONF.	BOX	CAT.
CO108S.1212	1/2"	1,20	10	-	B
CO108S.3434	3/4"	2,08	10	-	B
CO108S.0101	1"	3,43	10	-	B
CO108S.P4P4	1 1/4"	5,67	10	-	B
CO108S.P2P2	1 1/2"	7,59	10	-	B



112S

NIPPLO RIDOTTO

CODICE	Ø	PREZZO (€)	CONF.	BOX	CAT.
CO112S.1238	1/2" x 3/8"	1,35	10	-	B
CO112S.3412	3/4" x 1/2"	2,29	10	-	B
CO112S.0134	1" x 3/4"	3,54	10	-	B
CO112S.P401	1 1/4" x 1"	5,25	10	-	B
CO112S.P2P4	1 1/2" x 1 1/4"	9,72	10	-	B



114

RIDUZIONE M/F

CODICE	Ø	PREZZO (€)	CONF.	BOX	CAT.
CO114.1238	1/2" x 3/8"	0,88	10	-	B
CO114.3412	3/4" x 1/2"	1,66	10	-	B
CO114.0134	1" x 3/4"	2,13	10	-	B
CO114.P401	1 1/4" x 1"	4,32	10	-	B
CO114.P201	1 1/2" x 1"	7,49	10	-	B



116

MAGGIORATORE M/F

CODICE	Ø	PREZZO (€)	CONF.	BOX	CAT.
CO116.1238	1/2" x 3/8"	1,61	10	-	B
CO116.3412	3/4" x 1/2"	1,66	10	-	B
CO116.0134	1" x 3/4"	2,96	10	-	B
CO116.P401	1 1/4" x 1"	4,99	10	-	B
CO116.P201	1 1/2" x 1"	7,70	10	-	B



200

GOMITO FEMMINA

CODICE	Ø	PREZZO (€)	CONF.	BOX	CAT.
CO200.1212	1/2"	2,70	10	-	B
CO200.3434	3/4"	4,73	10	-	B
CO200.0101	1"	8,00	10	-	B
CO200.P4P4	1 1/4"	13,36	10	-	B



205

TEE FEMMINA

CODICE	Ø	PREZZO (€)	CONF.	BOX	CAT.
CO205.1212	1/2"	3,64	10	-	B
CO205.3434	3/4"	5,56	10	-	B
CO205.0101	1"	10,14	10	-	B
CO205.P4P4	1 1/4"	15,60	10	-	B



210P

GOMITO MASCHIO/FEMMINA

CODICE	Ø	PREZZO (€)	CONF.	BOX	CAT.
CO210P.1212	1/2"	3,85	10	-	B
CO210P.3434	3/4"	5,46	10	-	B
CO210P.0101	1"	8,32	10	-	B
CO210P.P4P4	1 1/4"	15,39	10	-	B



416

BOCCHETTONE M/F

CODICE	Ø	PREZZO (€)	CONF.	BOX	CAT.
TE416.250	3/4"	5,70	15	135	B
TE416.320	1"	9,00	10	90	B
TE416.400	1 1/4"	13,65	10	60	B
TE416.500	1 1/2"	26,25	6	36	B



538

BUSSOLA RIDUZIONE OTTONE

CODICE	Ø	PREZZO (€)	CONF.	BOX	CAT.
OV538.002	3/8"x1/4"	1,25	1	-	B
OV538.023	3/4"x1/4"	2,70	1	-	A
OV538.022	1/2"x1/4"	1,69	1	-	A



745

DISTANZIATORE M/F OTTONE

CODICE	Ø	PREZZO (€)	CONF.	BOX	CAT.
OV745.200	1/2" x 60 mm	4,30	1	-	B
OV745.250	3/4" x 50 mm	4,30	1	-	B

ELETTROPOMPE



JSW2C - 5:70 LT/MIN - 47:20 H/M
JSW2A - 5:70 LT/MIN - 55:28 H/M
JSW3CH - 10:80 LT/MIN - 55:30 H/M

ELETTROPOMPE PEDROLLO

CODICE	Ø	PREZZO (€)	CONF.	BOX	CAT.
PD.JSW2C	1 HP	172,00	1	-	C
PD.JSW2A	1,5 HP	195,00	1	-	C
PD.JSW3CH	1,5 HP	345,00	1	-	C



DAB

JET102: 0,75 KW MONOFASE 220 V
JET151: 1,1 KW MONOFASE 220 V

ELETTROPOMPE AUTOADESCANTI

CODICE	Ø	PREZZO (€)	CONF.	BOX	CAT.
DABJET102	1 HP	158,00	1	-	C
DABJET151	1,5 HP	349,00	1	-	C



MULTI2 10÷80 LT/MIN - 40/5 HMT 1"¼
MULTI3 10÷120 LT/MIN - 32/4 HMT 1"¼

ELETTROPOMPA SOMMERSIBILE

CODICE	Ø	PREZZO (€)	CONF.	BOX	CAT.
PD.MULTI2	0,75 hp	244,00	1	-	C
PD.MULTI3	0,75 hp	254,00	1	-	C



PRESSIONE 1÷9 BAR PROTEZIONE IP65
ALIMENTAZIONE 230V FREQ. 25/60 HZ

INVERTER MONOFASE

CODICE	Ø	PREZZO (€)	CONF.	BOX	CAT.
DG.MM85	8,5 A - 1"	422,00	1	-	C
DG.MM12	13 A - 1"	505,00	1	-	C



POTENZA 2 HP - 1.5 KW PRESSIONE DI PARTENZA 1,5 BAR PORTATA MAX 12 MC/H

PRESSOSTATO ELETTRONICO

CODICE	Ø	PREZZO (€)	CONF.	BOX	CAT.
PD.EP2	1" 16 AMP	79,00	1	-	C



IMPOSTABILE TRA 1 E 5 BAR
PORTATA MAX 12 MC/HZ

PRESSOSTATO CON SERBATOIO 3 LT

CODICE	Ø	PREZZO (€)	CONF.	BOX	CAT.
PD.EASYPRO	1"	154,00	1	-	C

ACCESSORI ELETTROPOMPE



SERBATOIO SFERICO

CODICE	Ø	PREZZO (€)	CONF.	BOX	CAT.
TR.S24V	24 LT	29,00	1	-	C



SERBATOIO CILINDRICO

CODICE	Ø	PREZZO (€)	CONF.	BOX	CAT.
TR.S60-0	60 LT	114,00	1	-	C



RACCORDO TRE VIE

CODICE	Ø	PREZZO (€)	CONF.	BOX	CAT.
TR.R3VIE	1"	6,50	1	-	C



RACCORDO 5 VIE

CODICE	Ø	PREZZO (€)	CONF.	BOX	CAT.
TR.R5VIE	1"	6,50	1	-	C



FLESSIBILE 60 CM

CODICE	Ø	PREZZO (€)	CONF.	BOX	CAT.
TR.FLESS60	1"	12,00	1	-	C



PRESSOSTATO

CODICE	Ø	PREZZO (€)	CONF.	BOX	CAT.
TR.PRESS	-	24,00	1	-	C

IRRIGATORI A BATTENTE 1/2" MASCHIO



P23

PORTATA MAX 15 LT/MIN. - GITTATA
MAX. 12 MT - PRESS. 3,5 ATM

IRRIGATORE 1/2" METALLO

CODICE	DESCR.	PREZZO (€)	CONF.	BOX	CAT.
IR.P2312	Attacco 1/2" M	15,40	10	50	B



P27

PORTATA MAX 14 LT/MIN. - GITTATA
MAX. 12 MT - PRESS. MIN 2 ATM

IRRIGATORE 1/2" IN PLASTICA

CODICE	DESCR.	PREZZO (€)	CONF.	BOX	CAT.
IR.P27	Attacco 1/2" M	4,80	10	50	B

IRRIGATORI A BATTENTE IDROMECCANICA ROSSI



RS

PORTATA 11/45 LT/MIN. - GITTATA 11/16 MT
PRESS. MIN 1,5 ATM

IRRIGATORE 3/4" F.

CODICE	DESCR.	PREZZO (€)	CONF.	BOX	CAT.
RO.R3S	3 ugelli incl.	38,67	1	-	B



RS

PORTATA 18/85 LT/MIN. - GITTATA 13,5/19 MT
PRESS. MIN 1,5 ATM

IRRIGATORE 1" F.

CODICE	DESCR.	PREZZO (€)	CONF.	BOX	CAT.
RO.R6S	3 ugelli incl.	51,50	1	-	B



RS

PORTATA 48/208 LT/MIN. - GITTATA 15/25 MT
PRESS. MIN 2 ATM

IRRIGATORE 1" 1/4 F.

CODICE	DESCR.	PREZZO (€)	CONF.	BOX	CAT.
RO.R15S	1" 1/4 F.	82,70	1	-	B



RS

PORTATA 88/648 LT/MIN. - GITTATA 18/39 MT
PRESS. MIN 2 ATM

IRRIGATORE 1" 1/2 F.

CODICE	DESCR.	PREZZO (€)	CONF.	BOX	CAT.
RO.R25S	1" 1/2 F.	114,50	1	-	B

TREPIEDI SUPPORTO IRRIGATORI



779

TREPIEDE ZINCATO
CON PORTAGOMMA

TREPIEDE 1/2"

CODICE	DESCR.	PREZZO (€)	CONF.	BOX	CAT.
VA.779D12	1/2"	11,00	1	10	B



77X

TREPIEDE ZINCATO
ALTEZZA TUBO REGOLABILE

TREPIEDI 3/4" E 1"

CODICE	DESCR.	PREZZO (€)	CONF.	BOX	CAT.
VA.779BD34	3/4" M	22,00	1	4	B
VA.778D1	1" M	22,00	1	4	B



77X

TREPIEDE ZINCATO
ALTEZZA TUBO REGOLABILE

TREPIEDE 1" 1/4"

CODICE	DESCR.	PREZZO (€)	CONF.	BOX	CAT.
VA.777D14	1" 1/4 M	29,50	1	1	B



776

TREPIEDE ZINCATO
ALTEZZA PIEDI REGOLABILE

TREPIEDE 1" 1/2"

CODICE	DESCR.	PREZZO (€)	CONF.	BOX	CAT.
VA.776D15	1" 1/2 F	57,90	1	1	B

RIDUTTORI DI PRESSIONE



DG5

RIDUTTORE DI PRESSIONE M/F

CODICE	DESCR.	PREZZO (€)	CONF.	BOX	CAT.
IR.DG06C	3/4" - 0,6 BAR	11,80	1	100	A
IR.DG10C	3/4" - 1,0 BAR	11,80	1	100	A
IR.DG13C	3/4" - 1,3 BAR	11,80	1	100	A



PRP

RIDUTTORE DI PRESSIONE M/F

CODICE	DESCR.	PREZZO (€)	CONF.	BOX	CAT.
IR.PRP10C	3/4" - 1,0 BAR	9,45	1	125	A
IR.PRP14C	3/4" - 1,4 BAR	9,45	1	125	A



MPD

RIDUTTORE DI PRESSIONE F/F 1"

CODICE	DESCR.	PREZZO (€)	CONF.	MC/H	CAT.
IR.MPD10	1" - 1,0 bar	26,30	1	0,5/4,5	A
IR.MPD14	1" - 1,4 bar	26,30	1	0,5/4,5	A
IR.MPD20	1" - 2,0 bar	26,30	1	0,5/4,5	A
IR.MPD27	1" - 2,7 bar	26,30	1	0,5/4,5	A



MPE

RIDUTTORE DI PRESSIONE F/F 1"1/4

CODICE	DESCR.	PREZZO (€)	CONF.	MC/H	CAT.
IR.MPE10	1"1/4 - 1,0 bar	52,90	1	2,3/7,3	A
IR.MPE14	1"1/4 - 1,4 bar	52,90	1	2,3/7,3	A
IR.MPE20	1"1/4 - 2,0 bar	52,90	1	2,3/7,3	A
IR.MPE27	1"1/4 - 2,7 bar	52,90	1	2,3/7,3	A



PSI

RIDUTTORE DI PRESSIONE RAINBIRD

CODICE	DESCR.	PREZZO (€)	CONF.	BOX	CAT.
RB.M25	3/4" - 1,75 BAR	19,90	1	80	A
RB.M30	3/4" - 2,1 BAR	19,90	1	80	A
RB.M40	3/4" - 2,8 BAR	19,90	1	80	A



PGG

MANOMETRO ALLA GLICERINA

CODICE	SCALA	PREZZO (€)	CONF.	BOX	CAT.
IR.PGG06	0 - 6 atm	18,20	1	100	A
IR.PGG10	0 - 10 atm	18,20	1	100	A

ACCESSORI



FUS

FUSTELLA FORATUBO

CODICE	Ø	PREZZO (€)	CONF.	BOX	CAT.
IRFUS.025	2,5 mm	9,60	1	10	A
IRFUS.036	3,6 mm	9,60	1	10	A
IRFUS.050	5,0 mm	9,60	1	10	A



PUN

PUNZONE RICAMBIO FUSTELLA

CODICE	Ø	PREZZO (€)	CONF.	BOX	CAT.
IRPUN.025	2,5 mm	3,90	1	-	A
IRPUN.036	3,6 mm	3,90	1	-	A
IRPUN.050	5,0 mm	3,90	1	-	A



PFU

PINZA/FUSTELLA FORATUBO

CODICE	Ø	PREZZO (€)	CONF.	BOX	CAT.
IR.PFU320	16-20	23,10	1	-	A
IR.PFU332	25-32	33,00	1	-	A



INS

INSERITORE INNESTI SU MICROTUBO

CODICE	Ø	PREZZO (€)	CONF.	BOX	CAT.
IR.INS50	5/6 mm.	36,00	1	-	A
IR.INS70	7/8 mm.	36,00	1	-	A



FOR

PINZA FORATRICE PER LAYFLAT

CODICE	Ø	PREZZO (€)	CONF.	BOX	CAT.
IR.FOR001	14	117,00	1	-	A
IR.FOR002	20	195,00	1	-	A



CDL

CHIAVE DERIVAZIONE LAYFLAT

CODICE	Ø FORO	PREZZO (€)	CONF.	BOX	CAT.
IR.CDL26	14	4,50	1	10	A
IR.CDL32	20	4,65	1	10	A

FORCELLE FISSATELO E ALA GOCCIOLANTE



FORCELLA IN FERRO ACCIAIOSO EFFETTO MOLLA

FORCELLA TESTA TONDA SFUSA

CODICE	MISURA	PREZZO (€)	CONF.	BOX	CAT.
KY.ALA17	17x3x17	0,110	SFUSO	500	B
KY.ALA23	23x3x23	0,132	SFUSO	300	B

MISURA 17 MM - PIANO BANCALE DA 14 SCATOLE (7.000 PZ) MASSIMO 3 PIANI (21.000 PZ)



FISSA ALA GOCCIOLANTE - 17 CM

FORCELLA TESTA TONDA 20 PZ

CODICE	MISURA	PREZZO (€)	CONF.	BOX	CAT.
KY.TA1720	17x3x17	3,300	20 PZ	25 CF	B



FORCELLA IN FERRO ACCIAIOSO EFFETTO MOLLA

FORCELLA TESTA QUADRA SFUSA

CODICE	MISURA	PREZZO (€)	CONF.	BOX	CAT.
KY.TELO17	17x3x17	0,110	SFUSO	500	B
KY.TELO23	23x3x23	0,132	SFUSO	300	B

MISURA 23 MM - PIANO BANCALE DA 14 SCATOLE (4.200 PZ) MASSIMO 3 PIANI (12.600 PZ)



FISSA TELO - 17 CM

FORCELLA TESTA QUADRA 20 PZ

CODICE	MISURA	PREZZO (€)	CONF.	BOX	CAT.
KY.TT1720	17x3x17	3,300	20 PZ	25 CF	B

PDL



PICCHETTO DI FISSAGGIO

CODICE	Ø	PREZZO (€)	CONF.	BOX	CAT.
IR.PDL160	16	0,21	25	400	A
IR.PDL200	20	0,21	-	400	A

TECO



PICCHETTO PER TUBI Ø 16 E 20

CODICE	Ø	PREZZO (€)	CONF.	BOX	CAT.
TC.101743	NERO	0,31	25	-	A
TC.103943	MARRONE	0,32	25	-	A

GRG



GANCIO SOSTEGNO ROMPIGOCCIA

CODICE	Ø	PREZZO (€)	CONF.	BOX	CAT.
IR.GRG160	16	0,049	500	6000	A
IR.GRG200	20	0,079	200	4000	A

GRL



GANCIO ROMPIGOCCIA LUNGO

CODICE	Ø	PREZZO (€)	CONF.	BOX	CAT.
IR.GRL160	16	0,228	-	1500	A
IR.GRL200	20	0,237	-	1200	A



SFIATO D'ARIA SINGOLO EFFETTO

CODICE	DESCR.	PREZZO (€)	CONF.	BOX	CAT.
IR.SSE250	¾"	25,35	1	10	A
IR.SSE320	1"	25,35	1	10	A



VFL

VALVOLA FINE LINEA ¾ F.

CODICE	APERTURA BAR	PREZZO (€)	CONF.	BOX	CAT.
IR.VFL250	arancio 0,09	1,06	100	700	A
IR.VFL25W	bianco 0,06	1,06	100	700	A



IVP

INIETTORE VENTURI

CODICE	DESCR.	PREZZO (€)	CONF.	BOX	CAT.
IR.IVP25B	¾" - 100 lt/h	48,83	1	40	A
IR.IVP32C	1" - 350 lt/h	55,80	1	16	A
IR.IVP50B	1½" - 700 lt/h	115,48	1	8	A



KIT ASPIRAZIONE PER VENTURI

CODICE	DESCR.	PREZZO (€)	CONF.	BOX	CAT.
IR.KVP-C	¾"	17,83	1	10	A
IR.KVP-DF	1" e 1½"	19,38	1	10	A



YDV

FILTRO 120 MESH RETE INOX

CODICE	Ø	PREZZO (€)	CONF.	BOX	CAT.
IR.YDV250	¾"	8,70	1	20	A
IR.YDV320	1"	9,00	1	20	A
IR.YEV400	1"¼	12,60	1	10	A
IR.YEV500	1"½	12,75	1	10	A
IR.YFV630	2"	21,30	1	10	A



YFV

FILTRO 120 MESH A DISCHI

CODICE	Ø	PREZZO (€)	CONF.	BOX	CAT.
IR.YDV34D	¾"	10,90	1	20	A
IR.YDV1D	1"	11,40	1	20	A
IR.YEV14D	1"¼	18,45	1	10	A
IR.YFV12D	1"½	35,90	1	10	A
IR.YFV2D	2"	37,35	1	10	A



FM

RICAMBIO RETE INOX

CODICE	Ø	PREZZO (€)	CONF.	BOX	CAT.
IR.FMD	¾" e 1"	5,20	1	-	A
IR.FME	1"¼ e 1"½	5,70	1	-	A
IR.FMF	2"	14,62	1	-	A



FM

RICAMBIO DISCHI

CODICE	Ø	PREZZO (€)	CONF.	BOX	CAT.
IR.FMDD	1"	8,16	1	-	A
IR.FMFD	1"½ e 2"	18,60	1	-	A



TGF

ROTODISC 2" 120 MESH A DISCHI

CODICE	Ø	PREZZO (€)	M³/H	BOX	CAT.
IR.TGF630R	2"	266,00	30	1	A



THF

ROTODISC 3" 120 MESH A DISCHI

CODICE	Ø	PREZZO (€)	M³/H	BOX	CAT.
IR.THF900R	3"	348,00	50	1	A



YGG

FILTRO IN LINEA CON GHIERA

CODICE	Ø	PREZZO (€)	M³/H	BOX	CAT.
IR.YGG630	2" rete inox	114,90	25	1	A
IR.YGG2D	2" dischi	132,00	25	1	A



YGF

FILTRO IN LINEA FASCIA INOX

CODICE	Ø	PREZZO (€)	M³/H	BOX	CAT.
IR.YGF630	2" rete inox	177,00	25	1	A
IR.YGF2D	2" dischi"	199,00	25	1	A



FMG

RICAMBI PER YGG E YGF

CODICE	Ø	PREZZO (€)	M³/H	BOX	CAT.
IR.FMG12	2" INOX	72,00	25	1	A
IR.FMGD12	2" DISCHI	84,00	25	1	A



ROTO

RICAMBI PER TGF E THF

CODICE	Ø	PREZZO (€)	M³/H	BOX	CAT.
IR.FMGR2	2" ROTO	120,00	30	1	A
IR.TMHR3	3" ROTO	144,00	50	1	A



EIV

SEPARATORE SABBIA IDROCICLONE

CODICE	Ø	PREZZO (€)	M³/H	BOX	CAT.
IR.EIV250	¾"	342,00	3-5	1	A
IR.EIV320	1"	388,50	5-12	1	A
IR.EIV500	1"½	417,00	10-16	1	A
IR.EIV630	2"	1056,00	15-25	1	A



PGG

MANOMETRO ALLA GLICERINA

CODICE	SCALA	PREZZO (€)	CONF.	BOX	CAT.
IR.PGG06	0 - 6 atm	14,90	1	100	A
IR.PGG10	0 - 10 atm	14,90	1	100	A
RIDUZIONI					
OV538.002	3/8"x1/4"	1,25	1	-	B
OV538.023	3/4"x1/4"	2,70	1	-	B
OV538.022	1/2"x1/4"	1,69	1	-	B



JUNIOR

ALA GOCCIOLANTE PESANTE PLURISTAGIONALE
IDEALE PER AIUOLE GIARDINAGGIO ORTI
GOCCIOLATORE 2,1 LT/H

Ø 16 - NERA



CODICE	DESCRIZIONE	PREZZO (€)	CONF.	PLT	CAT.
SP.DBJ325	Junior mt 25 ø 16 spaziatura 33 cm	12,30	1	110	A
SP.DBJ305	Junior mt 50 ø 16 spaziatura 33 cm	21,98	1	80	A
SP.DBJ301	Junior mt 100 ø 16 spaziatura 33 cm	40,50	1	56	A



TANDEM

ALA GOCCIOLANTE PESANTE PLURISTAGIONALE
IDEALE PER AIUOLE GIARDINAGGIO ORTI
GOCCIOLATORE 2,1 LT/H

Ø 16 - NERA
100 MT



CODICE	DESCRIZIONE	PREZZO (€)	CONF.	PLT	CAT.
SP.DBA205	Tandem mt 50 ø 16 spaziatura 20 cm	28,91	1	80	A
SP.DBA201	Tandem mt 100 ø 16 spaziatura 20 cm	54,25	1	56	A
SP.DBA325	Tandem mt 25 ø 16 spaziatura 33 cm	13,35	1	110	A
SP.DBA305	Tandem mt 50 ø 16 spaziatura 33 cm	24,08	1	80	A
SP.DBA301	Tandem mt 100 ø 16 spaziatura 33 cm	44,70	1	56	A
SP.DBA301.4	Tandem mt 100 ø 16 spaziatura 33 cm - 4 LT/ORAZIONE	44,70	1	56	A



TANDEM

ALA GOCCIOLANTE PESANTE PLURISTAGIONALE
IDEALE PER AIUOLE GIARDINAGGIO ORTI
GOCCIOLATORE 2,1 LT/H

Ø 20 - NERA
100 MT

CODICE	DESCRIZIONE	PREZZO (€)	CONF.	PLT	CAT.
SP.DBB301	Tandem mt 100 ø 20 spaziatura 33 cm	60,60	1	56	A



TANDEM MARRONE

ALA GOCCIOLANTE PESANTE PLURISTAGIONALE
IDEALE PER AIUOLE GIARDINAGGIO ORTI
GOCCIOLATORE 2,1 LT/H

Ø 16 - MARRONE



CODICE	DESCRIZIONE	PREZZO (€)	CONF.	PLT	CAT.
SP.DBM303	Tandem Marrone mt 25 ø 16 spaziatura 30 cm	13,61	1	110	A
SP.DBM305	Tandem Marrone mt 50 ø 16 spaziatura 30 cm	24,60	1	80	A
SP.DBM301	Tandem Marrone mt 100 ø 16 spaziatura 30 cm	45,75	1	56	A

ALI GOCCIOLANTI AUTOCOMPENSANTI IN BOBINE DA 100 MT



MULTIBAR

ALA GOCCIOLANTE PESANTE PLURISTAGIONALE
IDEALE PER AIUOLE GIARDINAGGIO ORTI
GOCCIOLATORE 2,1 LT/H

AUTOCOMPENSANTE
Ø 16 - 100 MT - NERA



CODICE	DESCRIZIONE	PREZZO (€)	CONF.	PLT	CAT.
SP.DMU301	Multibar autocompensante mt 100 ø 16 spaz. 30 cm	72,90	1	56	A

MULTIBAR MARRONE

ALA GOCCIOLANTE PESANTE PLURISTAGIONALE
IDEALE PER AIUOLE GIARDINAGGIO ORTI
GOCCIOLATORE 2,1 LT/H

AUTOCOMPENSANTE
Ø 16 - 100 MT - MARRONE



CODICE	DESCRIZIONE	PREZZO (€)	CONF.	PLT	CAT.
SP.DMM301	Multibar autocomp. Marrone mt 100 ø 16 spaz.30 cm	72,90	1	56	A

ALI GOCCIOLANTI IN ROTOLI STANDARD (300/400 MT)



JUNIOR

ALA GOCCIOLANTE PLURISTAGIONALE
PORTATA VARIABILE A SECONDA DELLA PRESSIONE
CONSIGLIATA PER SERRE COLTURE IN PIENO CAMPO

ALA GOCCIOLANTE Ø 16
BOBINE STANDARD

CODICE	DESCRIZIONE	PREZZO (€)	CONF.	BOX	CAT.
SP.DJ130A	Ala gocciolante ø 16 spaziatura 30 cm - 2,1 lt/h	0,375	400	-	A

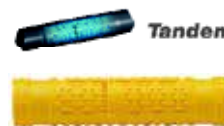

TANDEM

ALA GOCCIOLANTE PLURISTAGIONALE DOPPIA FORATURA
PORTATA VARIABILE A SECONDA DELLA PRESSIONE
CONSIGLIATA PER SERRE COLTURE IN PIENO CAMPO

ALA GOCCIOLANTE Ø 16
BOBINE STANDARD

CODICE	DESCRIZIONE	PREZZO (€)	CONF.	BOX	CAT.
SP.DL130A	Ala gocciolante ø 16 Tandem spaz. 33 cm - 2,1 lt/h	0,410	400	-	A
SP.DL140A	Ala gocciolante ø 16 Tandem spaz. 40 cm - 2,1 lt/h	0,390	400	-	A



TANDEM

ALA GOCCIOLANTE PLURISTAGIONALE DOPPIA FORATURA
PORTATA VARIABILE A SECONDA DELLA PRESSIONE
CONSIGLIATA PER SERRE COLTURE IN PIENO CAMPO

ALA GOCCIOLANTE Ø 20
BOBINE STANDARD

CODICE	DESCRIZIONE	PREZZO (€)	CONF.	BOX	CAT.
SP.DL230A	Ala gocciolante ø 20 Tandem spaz. 33 cm - 2,1	0,560	300	-	A
SP.DL240A	Ala gocciolante ø 20 Tandem spaz. 40 cm - 2,1 lt/h	0,520	300	-	A

ALI GOCCIOLANTI AUTOCOMPENSANTI (300/400 MT)



MULTIBAR

ALA GOCCIOLANTE AUTOCOMPENSANTE
OMOGENEITA' CON LINEE LUNGHE E PENDENZE
A RICHIESTA CON GOCCIOLATORE 1,5 - 2,9 E 3,8 LT/H

Ø 16 AUTOCOMPENSANTE
BOBINE STANDARD

CODICE	DESCRIZIONE	PREZZO (€)	CONF.	BOX	CAT.
SP.DMU140A	Ala gocciolante ø 16 Multibar spaz. 40 cm - 2,1 lt/h	0,630	400	-	A
SP.DMU150A	Ala gocciolante ø 16 Multibar spaz. 50 cm - 2,1 lt/h	0,580	400	-	A
SP.DMU160A	Ala gocciolante ø 16 Multibar spaz. 60 cm - 2,1 lt/h	0,550	400	-	A



MULTIBAR

ALA GOCCIOLANTE AUTOCOMPENSANTE
OMOGENEITA' CON LINEE LUNGHE E PENDENZE
A RICHIESTA CON GOCCIOLATORE 1,5 - 2,9 E 3,8 LT/H

Ø 20 AUTOCOMPENSANTE
BOBINE STANDARD

CODICE	DESCRIZIONE	PREZZO (€)	CONF.	BOX	CAT.
SP.DMU240A	Ala gocciolante ø 20 Multibar spaz. 40 cm - 2,1 lt/h	0,780	300	-	A
SP.DMU250A	Ala gocciolante ø 20 Multibar spaz. 50 cm - 2,1 lt/h	0,730	300	-	A
SP.DMU260A	Ala gocciolante ø 20 Multibar spaz. 60 cm - 2,1 lt/h	0,690	300	-	A



ROOTGUARD

ALA GOCCIOLANTE AUTOCOMPENSANTE PER INTERRO
OMOGENEITA' CON LINEE LUNGHE E PENDENZE
GOCCIOLATORE 1,5 - 2,1 - 2,9 - 3,8 LT/H

ALA GOCC. AUTOCOMPENSANTE
PER SUB-IRRIGAZIONE

CODICE	DESCRIZIONE	PREZZO (€)	CONF.	BOX	CAT.
SP.RG1630	Ala Rootguard Multibar ø 16 spaziatura 30 cm	SU RICHIESTA	400	-	A
SP.RG1660	Ala Rootguard Multibar ø 16 spaziatura 60 cm	SU RICHIESTA	400	-	A
SP.RG16100	Ala Rootguard Multibar ø 16 spaziatura 100 cm	SU RICHIESTA	400	-	A

ALA GOCCIOLANTE LEGGERA



P1

PORTATA VARIABILE A SECONDA DELLA PRESSIONE
GOCCIOLATORE PIATTO CON FILTRO IN INGRESSO
A RICHIESTA ANCHE CON GOCCIOLATORE 1,5 E 2,1 LT/H

ALA GOCCIOLANTE LEGGERA BOBINE

CODICE	DESCRIZIONE	PREZZO (€)	CONF.	PLT	CAT.
BOBINE RIDOTTE					
AI.P181620.1	P1 ø 16 mm. Spaz. 20 cm - 8 mil 100 MT - 1,5 lt/h	0,240	100	25600	A
AI.P181620.2	P1 ø 16 mm. Spaz. 20 cm - 8 mil 250 MT - 1,5 lt/h	0,178	250	24750	A
AI.P181620.8	P1 ø 16 mm. Spaz. 20 cm - 8 mil 1200 MT - 1,5 lt/h	0,147	1200	43200	A
BOBINE STANDARD					
AI.P181620	P1 ø 16 mm. Spaz. 20 cm - 8 mil 2.600 MT - 1,5 lt/h	0,126	2600	41600	A
AI.P181630	P1 ø 16 mm. Spaz. 30 cm - 8 mil 2.800 MT - 1,5 lt/h	0,118	2800	44800	A
AI.P181640	P1 ø 16 mm. Spaz. 40 cm - 8 mil 2.800 MT - 1,5 lt/h	0,114	2800	44800	A
AI.P1U82230	P1 Ultra ø 22 mm. Spaz. 30 cm - 8 mil 2.200 MT - 1,5 lt/h	0,147	2200	35600	A
AI.P1U82240	P1 Ultra ø 22 mm. Spaz. 40 cm - 8 mil 2,200 MT - 1,5 lt/h	0,144	2200	35600	A



FH

TUBO IN PVC FLESSIBILE LAY-FLAT

CODICE	Ø	PREZZO (€)	CONF.	BAR	CAT.
SP.FH15	1"½ - 40 mm	2,33	50/100	5	A
SP.FH2	2" - 52 mm	3,03	50/100	4,5	A
SP.FH25	2" ½ - 65mm	4,35	50/100	4	A
SP.FH3	3" - 77 mm	5,85	50/100	4	A
SP.FH4	4" - 103 mm	7,88	50/100	4	A
SP.FH5	5" - 128 mm	10,80	50/100	3	A



CO

FASCETTA PER LAYFLAT

CODICE	Ø	PREZZO (€)	CONF.	BOX	CAT.
IR.F5257	52 - 57	5,93	1	100	A
IR.F6773	67 - 73	8,03	1	50	A
IR.F7379	73 - 79	8,25	1	50	A
IR.F95105	95 - 105	9,00	1	50	A
IR.F123138	123 - 138	11,70	1	50	A
IR.F148162	148 - 162	13,35	1	25	A



782

RACCORDO MASCHIO PER LAYFLAT

CODICE	Ø	PREZZO (€)	CONF.	BOX	CAT.
IR782.52G	52 x 2"	6,63	1	-	A
IR782.65H	65 x 2"½	4,88	1	-	A
IR782.77I	77 x 3"	6,77	1	-	A



784

MANICOTTO PER LAYFLAT

CODICE	Ø	PREZZO (€)	CONF.	BOX	CAT.
IR784.520	52 x 52	3,78	1	-	A
IR784.650	65 x 65	6,04	1	-	A
IR784.770	77 x 77	7,32	1	-	A



770

RACCORDO SWIVEL PER LAYFLAT

CODICE	Ø	PREZZO (€)	CONF.	BOX	CAT.
IR770.52G	52 x 2"	6,95	1	-	A
IR770.65H	65 x 2"½	10,58	1	-	A
IR770.77I	77 x 3"	12,07	1	-	A



FOR

PINZA FORATRICE PER FLAT-HOSE

CODICE	Ø	PREZZO (€)	CONF.	BOX	CAT.
IR.FOR001	14	117,00	1	-	A
IR.FOR002	20	195,00	1	-	A



602

RACCORDO MASCHIO

CODICE	Ø	PREZZO (€)	CONF.	BOX	CAT.
IR602.16B	16x1/2"	0,27	20	-	A
IR602.16C	16x3/4"	0,31	20	-	A
IR602.20B	20x1/2"	0,32	20	-	A
IR602.20C	20x3/4"	0,32	20	-	A
IR602.25C	25x3/4"	0,35	100	-	A
IR602.32D	32x1"	0,48	50	-	A



606

TEE

CODICE	Ø	PREZZO (€)	CONF.	BOX	CAT.
IR606.160	16	0,20	20	-	A
IR606.200	20	0,29	20	-	A
IR606.250	25	0,78	50	-	A
IR606.320	32	0,94	25	-	A



640

GOMITO

CODICE	Ø	PREZZO (€)	CONF.	BOX	CAT.
IR640.160	16	0,26	20	-	A
IR640.200	20	0,29	20	-	A
IR640.250	25	0,71	100	-	A
IR640.320	32	0,93	50	-	A



642

GOMITO RIDOTTO

CODICE	Ø	PREZZO (€)	CONF.	BOX	CAT.
IR642.20A	20x16	0,75	100	-	A



603

MANICOTTO RIDOTTO

CODICE	Ø	PREZZO (€)	CONF.	BOX	CAT.
IR603.20A	20x16	0,26	100	-	A



RPP

VALVOLINA DOPPIO PORTAGOMMA

CODICE	Ø	PREZZO (€)	CONF.	BOX	CAT.
IR.RPP250	25	1,81	50	150	A



604

GIUNZIONE

CODICE	Ø	PREZZO (€)	CONF.	BOX	CAT.
IR604.160	16	0,18	20	-	A
IR604.200	20	0,25	20	-	A
IR604.250	25	0,33	50	-	A
IR604.320	32	0,43	50	-	A



608

TEE FILETTO MASCHIO

CODICE	Ø	PREZZO (€)	CONF.	BOX	CAT.
IR608.16B	16x1/2"x16	0,30	100	-	A
IR608.16C	16x3/4"x16	0,30	100	-	A
IR608.20B	20x1/2"x20	0,60	100	-	A
IR608.20C	20x3/4"x20	0,60	100	-	A



641

GOMITO MASCHIO PORTAGOMMA

CODICE	Ø	PREZZO (€)	CONF.	BOX	CAT.
IR641.16B	16x1/2"	0,36	20	-	A
IR641.16C	16x3/4"	0,38	20	-	A
IR641.20B	20x1/2"	0,41	100	-	A
IR641.20C	20x3/4"	0,42	100	-	A



600

TAPPO

CODICE	Ø	PREZZO (€)	CONF.	BOX	CAT.
IR600.160	16	0,08	50	-	A
IR600.200	20	0,18	500	-	A



648

PORTAGOMMA CON GHIERA

CODICE	Ø	PREZZO (€)	CONF.	BOX	CAT.
IR648.16B	16x1/2"	0,68	100	1300	A
IR648.16C	16x3/4"	0,71	100	1200	A



RMP

VALVOLINA M/PORTAGOMMA

CODICE	Ø	PREZZO (€)	CONF.	BOX	CAT.
IR.RMP.25C	25x3/4"	1,81	50	150	A



810

GIUNZIONE

CODICE	Ø	PREZZO (€)	CONF.	BOX	CAT.
IR810.160	16x16	0,91	50	-	A
IR810.200	20x20	1,24	50	-	A
IR812.20A	16x20	1,44	50	-	A



814

TEE

CODICE	Ø	PREZZO (€)	CONF.	BOX	CAT.
IR814.160	16x16x16	1,70	30	-	A
IR814.200	20x20x20	2,32	30	-	A
IR814.20A	20x16x20	1,98	30	-	A



823

GOMITO

CODICE	Ø	PREZZO (€)	CONF.	BOX	CAT.
IR823.160	16	1,26	50	-	A
IR823.200	20	1,54	50	-	A



813

TAPPO

CODICE	Ø	PREZZO (€)	CONF.	BOX	CAT.
IR813.160	16	0,71	100	-	A
IR813.200	20	0,81	100	-	A
IR813.250	25	1,01	50	-	A
IR813.320	32	1,29	50	-	A



VEE

VALVOLINA TUBO/TUBO

CODICE	Ø	PREZZO (€)	CONF.	BOX	CAT.
IR.VEE160	16	1,23	50	250	A
IR.VEE200	20	1,28	50	200	A



811

RACCORDO MASCHIO

CODICE	Ø	PREZZO (€)	CONF.	BOX	CAT.
IR811.16B	16x1/2"	0,68	50	-	A
IR811.16C	16x3/4"	0,68	50	-	A
IR811.20B	20x1/2"	0,89	50	-	A
IR811.20C	20x3/4"	0,89	50	-	A



816

TEE FILETTO MASCHIO

CODICE	Ø	PREZZO (€)	CONF.	BOX	CAT.
IR816.16C	16x3/4"x16	1,42	30	-	A
IR816.20B	20x1/2"x20	1,82	30	-	A
IR816.20C	20x3/4"x20	1,82	30	-	A



824

GOMITO MASCHIO

CODICE	Ø	PREZZO (€)	CONF.	BOX	CAT.
IR824.16B	16x1/2"	0,94	50	-	A
IR824.16C	16x3/4"	0,94	50	-	A
IR824.20B	20x1/2"	1,24	50	-	A
IR824.20C	20x3/4"	1,24	50	-	A



802

RACCORDO CON GHIERA

CODICE	Ø	PREZZO (€)	CONF.	BOX	CAT.
IR802.16C	16x3/4"	1,57	50	-	A



VME

VALVOLINA MASCHIO/TUBO

CODICE	Ø	PREZZO (€)	CONF.	BOX	CAT.
IR.VME16B	16x1/2"	1,06	50	300	A
IR.VME16C	16x3/4"	1,06	50	250	A
IR.VME20B	20x1/2"	1,10	50	250	A
IR.VME20C	20x3/4"	1,10	50	250	A

830



GIUNZIONE

CODICE	Ø	PREZZO (€)	CONF.	BOX	CAT.
IR830.160	16	0,14	100	-	A
IR830.200	20	0,20	100	-	A

841



GIUNZIONE CON ANELLO

CODICE	Ø	PREZZO (€)	CONF.	BOX	CAT.
IR841.160	16	0,29	100	-	A
IR841.200	20	0,32	100	-	A

832



RACCORDO MASCHIO

CODICE	Ø	PREZZO (€)	CONF.	BOX	CAT.
IR832.16B	16x1/2"	0,25	100	-	A
IR832.16C	16x3/4"	0,26	100	-	A

834



TEE

CODICE	Ø	PREZZO (€)	CONF.	BOX	CAT.
IR834.160	16	0,29	100	-	A
IR834.200	20	0,99	100	-	A

835



GOMITO

CODICE	Ø	PREZZO (€)	CONF.	BOX	CAT.
IR835.160	16	0,26	100	-	A



AFA

DOPPIO ANELLO DI CHIUSURA

CODICE	Ø	PREZZO (€)	CONF.	BOX	CAT.
IR.AFA160	16	0,10	200	2400	A
IR.AFA200	20	0,11	200	1600	A

840



GIUNZIONE CON GHIERA

CODICE	Ø	PREZZO (€)	CONF.	BOX	CAT.
IR840.160	16	0,61	20	-	A
IR840.200	20	0,76	20	-	A

842



RACCORDO MASCHIO CON GHIERA

CODICE	Ø	PREZZO (€)	CONF.	BOX	CAT.
IR842.16B	16x1/2"	0,52	20	-	A
IR842.16C	16x3/4"	0,59	20	-	A
IR842.20C	20x3/4"	0,73	20	-	A

843



PARTENZA CON GOMMINO

CODICE	Ø	PREZZO (€)	CONF.	BOX	CAT.
IR843.160		0,46	100	-	A

844



TEE CON GHIERA

CODICE	Ø	PREZZO (€)	CONF.	BOX	CAT.
IR844.160	16	1,04	20	-	A
IR844.200	20	1,32	10	-	A

846



TEE MASCHIO CON GHIERA

CODICE	Ø	PREZZO (€)	CONF.	BOX	CAT.
IR846.16B	16x1/2"x16	1,04	10	-	A
IR846.16C	16x3/4"x16	1,06	10	-	A
IR846.20C	20x3/4"x20	1,14	10	-	A

839



GOMITO CON GHIERA

CODICE	Ø	PREZZO (€)	CONF.	BOX	CAT.
IR839.160	16	0,63	50	-	A
IR839.200	20	0,76	50	-	A



850

GIUNZIONE

CODICE	Ø	PREZZO (€)	CONF.	BOX	CAT.
IR850.00T	16	0,41	100	-	A
IR850.00U	22	0,90	100	-	A



852

RACCORDO MASCHIO TAPE

CODICE	Ø	PREZZO (€)	CONF.	BOX	CAT.
IR852.20T	1/2"x16	0,43	100	-	A
IR852.25T	3/4"x16	0,45	100	-	A
IR852.25U	3/4"x22	0,65	100	-	A



857

TEE

CODICE	Ø	PREZZO (€)	CONF.	BOX	CAT.
IR857.00T	16	1,16	50	-	A



861

RACCORDO TAPE CON GHIERA

CODICE	Ø	PREZZO (€)	CONF.	BOX	CAT.
IR861.25T	3/4"x16	0,99	100	-	A
IR861.25U	3/4"x22	1,39	50	-	A



890

GIUNZIONE EASY-BLOCK

CODICE	Ø	PREZZO (€)	CONF.	BOX	CAT.
IR890.00T	16	0,35	100	-	A
IR890.00U	22	0,71	100	-	A



DCF

DERIVAZIONE LAYFLAT FILETTATA

CODICE	Ø	PREZZO (€)	CONF.	BOX	CAT.
IR.DCF250	3/4" F.	0,77	50	1000	A



TLF

TAPPO PER DERIVAZIONE

CODICE	Ø	PREZZO (€)	CONF.	BOX	CAT.
IR.TLF200	Foro 14 mm	0,61	50	700	A
IR.TLF25L	Foro 20 mm	1,10	50	1000	A



NEW

TR

VALVOLA MASCHIO/TAPE 16

CODICE	Ø	PREZZO (€)	CONF.	BOX	CAT.
TC.206735	TAPE 16x1/2"M	1,23	50	-	A
TC.206685	TAPE 16x3/4"M	1,26	50	-	A



851

GIUNZIONE PASSAGGIO TUBO/TAPE

CODICE	Ø	PREZZO (€)	CONF.	BOX	CAT.
IR851.16T	16xTape	0,35	100	-	A
IR851.20T	22xTape	0,42	100	-	A



853

PARTENZA CON GOMMINO

CODICE	Ø	PREZZO (€)	CONF.	BOX	CAT.
IR853.00T	16	0,39	100	-	A
IR853.00U	22	0,77	50	-	A



858

GOMITO

CODICE	Ø	PREZZO (€)	CONF.	BOX	CAT.
IR858.00T	16	0,99	50	-	A



866

DERIVAZIONE PER LAYFLAT

CODICE	Ø	PREZZO (€)	CONF.	BOX	CAT.
IR866.00T	16	0,66	100	-	A
IR866.00U	22	1,27	50	-	A



891

TAPPO EASY-BLOCK

CODICE	Ø	PREZZO (€)	CONF.	BOX	CAT.
IR891.00T	16	0,30	100	-	A
IR891.00U	22	0,48	100	-	A



DLF

DERIVAZIONE LAYFLAT FILETTATA

CODICE	Ø	PREZZO (€)	CONF.	BOX	CAT.
IR.DLF25B	3/4"M - 1/2 F.	0,58	50	1000	A



CDL

CHIAVE DERIVAZIONE LAYFLAT

CODICE	Ø FORO	PREZZO (€)	CONF.	BOX	CAT.
IR.CDL26	14	4,50	1	10	A
IR.CDL32	20	4,65	1	10	A



NEW

TR

VALVOLA MASCHIO/TAPE 22

CODICE	Ø	PREZZO (€)	CONF.	BOX	CAT.
TC.207155	TAPE 22x1/2"M	1,33	50	-	A
TC.206985	TAPE 22x3/4"M	1,36	50	-	A

VALVOLE A CILINDRO COMPACT



VPP

DOPPIO PORTAGOMMA

CODICE	Ø	PREZZO (€)	CONF.	BOX	CAT.
IR.VPP160	16	0,94	50	400	A
IR.VPP200	20	0,94	50	350	A



VDA

GOMMINO ALA GOCCIOLANTE

CODICE	Ø	PREZZO (€)	CONF.	BOX	CAT.
IR.VDA160	16	1,10	50	300	A
IR.VDA200	20	1,10	50	300	A



VEE

DOPPIO GIUNTO PN4

CODICE	Ø	PREZZO (€)	CONF.	BOX	CAT.
IR.VEE160	16	1,23	50	250	A
IR.VEE200	20	1,28	50	200	A



VTT

TAPE/TAPE

CODICE	Ø	PREZZO (€)	CONF.	BOX	CAT.
IR.VTT00T	16	1,23	50	250	A



VDT

GOMMINO/TAPE

CODICE	Ø	PREZZO (€)	CONF.	BOX	CAT.
IR.V5B	foro 5mm x 16	1,13	50	300	A
IR.VDT.00T	16	1,13	50	300	A

MINI VALVOLE A SFERA



SFF

FEMMINA/FEMMINA

CODICE	Ø	PREZZO (€)	CONF.	BOX	CAT.
IR.SFF250	¾"	1,28	50	300	A



VMP

MASCHIO PORTAGOMMA

CODICE	Ø	PREZZO (€)	CONF.	BOX	CAT.
IR.VMP16B	16x½"	0,96	50	400	A
IR.VMP16C	16x¾"	0,96	50	300	A
IR.VMP20B	20x½"	0,96	50	300	A
IR.VMP20C	20x¾"	0,96	50	300	A



VMA

MASCHIO ALA GOCCIOLANTE

CODICE	Ø	PREZZO (€)	CONF.	BOX	CAT.
IR.VMA16B	16x½"	1,06	50	300	A
IR.VMA16C	16x¾"	1,06	50	250	A
IR.VMA20C	20x¾"	1,10	50	250	A



VME

MASCHIO GIUNTO PN4

CODICE	Ø	PREZZO (€)	CONF.	BOX	CAT.
IR.VME16B	16x½"	1,06	50	300	A
IR.VME16C	16x¾"	1,06	50	250	A
IR.VME20B	20x½"	1,10	50	250	A
IR.VME20C	20x¾"	1,10	50	250	A



VMT

MASCHIO/TAPE

CODICE	Ø	PREZZO (€)	CONF.	BOX	CAT.
IR.VMT20T	16x½"	1,07	50	300	A
IR.VMT25T	16x¾"	1,07	50	250	A
IR.VMT25U	22x¾"	1,22	50	200	A



VMM

MASCHIO/MASCHIO

CODICE	Ø	PREZZO (€)	CONF.	BOX	CAT.
IR.VMM200	½"	0,96	50	300	A
IR.VMM250	¾"	0,96	50	250	A



SFM

MASCHIO/FEMMINA

CODICE	Ø	PREZZO (€)	CONF.	BOX	CAT.
IR.SFM250	¾"	1,10	50	300	A

SISTEMA GOCCIOLATORI I-DROP



DCG

AUTOCOMPENSANTE

CODICE	LT/H	PREZZO (€)	CONF.	BOX	CAT.
IR.DCG2	2	0,277	500	3000	A
IR.DCG4	4	0,277	500	3000	A
IR.DCG8	8	0,277	500	3000	A



DNG

NORMALE

CODICE	LT/H	PREZZO (€)	CONF.	BOX	CAT.
IR.DNG2	2	0,156	500	3000	A
IR.DNG4	4	0,156	500	3000	A
IR.DNG8	8	0,156	500	3000	A



ASD

ASTINA GOCCIOLATORE

CODICE	LT/H	PREZZO (€)	CONF.	BOX	CAT.
IR.ASD17	1,7	0,081	250	4000	A
IR.ASD26	2,6	0,081	250	4000	A



AID

ASTINA GOCCIOLATORE INCLINATA

CODICE	LT/H	PREZZO (€)	CONF.	BOX	CAT.
IR.AID15	2,6	0,140	250	1200	A



ASS

ASTINA SPRUZZO PER MICROTUBO

CODICE	LT/H	PREZZO (€)	CONF.	BOX	CAT.
IR.ASS	25	0,076	500	6000	A



ASG

ASTINA SOSTEGNO MICROTUBO

CODICE	Ø	PREZZO (€)	CONF.	BOX	CAT.
IR.ASG.000	3,5 x 5 mm	0,067	500	6000	A

SU RICHIESTA SONO DISPONIBILI LE BOBINE
CON IL CAPILLARE PREMONTATO



DCS

AUTOCOMPENSANTE DROP-STOP



CODICE	LT/H	PREZZO (€)	CONF.	BOX	CAT.
IR.DCS2	2	0,282	500	3000	A
IR.DCS4	4	0,282	500	3000	A
IR.DCS8	8	0,282	500	3000	A



MO

USCITE PER MICROTUBO

CODICE	Ø	PREZZO (€)	CONF.	BOX	CAT.
IR.MO1	1 uscita	0,049	-	500	A
IR.MO2	2 uscite	0,130	-	500	A
IR.MV4	4 uscite	0,146	-	500	A



MC

USCITE PER CAPILLARE 3,2 MM

CODICE	Ø	PREZZO (€)	CONF.	BOX	CAT.
IR.MC2	2 uscite	0,223	-	500	A
IR.MC4	4 uscite	0,223	-	500	A



ASC

ASTINA DUE FORI PER CAPILLARE

CODICE	Ø	PREZZO (€)	CONF.	BOX	CAT.
IR.ASC	2,5 e 3,2 mm	0,078	250	2500	A



AST

ASTINA PER CAPILLARE

CODICE	LT/H	PREZZO (€)	CONF.	BOX	CAT.
IR.AST	nero	0,076	800	3200	A



PE

MICROTUBO CAPILLARE

CODICE	Ø	PREZZO (€)	CONF.	BOX	CAT.
SP.PE1	0,8 x 3,2 mm	0,11	500	2500	A
SP.PE2	1,0 x 3,2 mm	0,11	500	2500	A
SP.PE3	1,2 x 3,2 mm	0,11	500	2500	A
SP.PE4	1,5 x 3,2 mm	0,11	500	2500	A

MICROTUBO PER IRRIGAZIONE A GOCCIA



200

MICROTUBO PVC PLASTIFICATO

CODICE	Ø	PREZZO €/MT	MT	BOX	CAT.
SP.20035	3 x 5,5	0,23	300	-	A
SP.20047	4 x 7	0,34	200	-	A
SP.20058	5 x 8	0,42	150	-	A



201

MICROTUBO IN PVC MORBIDO

CODICE	Ø	PREZZO €/MT	MT	BOX	CAT.
SP.20135	3 x 5,5	0,23	300	-	A
SP.20146	4 x 6	0,34	200	-	A
SP.20158	5 x 8	0,44	150	-	A



PEM

4X6 MM BOBINE PICCOLE

CODICE	Ø	PREZZO €/MT	MT	BOX	CAT.
TB.TC15	4 x 6	5,30	15	-	A
TB.TC25	4 x 6	7,70	25	-	A
TB.TC50	4 x 6	14,45	50	-	A



PEM

MICROTUBO IN PVC PLASTIFICATO

CODICE	Ø	PREZZO €/MT	MT	BOX	CAT.
TB.TC2	4 x 6	0,27	250	-	A

RACCORDI IRRITEC PER MICROTUBO



714

INNESTO AD OLIVETTA

CODICE	Ø	PREZZO (€)	CONF.	BOX	CAT.
IR714.037	3 x 5	0,045	500	-	A
IR714.040	4 x 6	0,045	500	-	A



715

INNESTO AD OLIVETTA

CODICE	Ø	PREZZO €/MT	CONF.	BOX	CAT.
IR715.050	3x5,5 (200/1)	0,045	500	12000	A
IR715.070	5 x 8 (200)	0,059	500	10000	A
IR715.080	5 x 8 (201)	0,065	500	8000	A



700

TAPPINO RIPARAZIONE

CODICE	Ø	PREZZO (€)	CONF.	BOX	CAT.
IR700.040	4 mm.	0,031	500	-	A
IR700.060	6 mm.	0,060	500	-	A



707

TEE DERIVAZIONE

CODICE	Ø	PREZZO (€)	CONF.	BOX	CAT.
IR707	3x5,5 / 4x6	0,135	500	-	A

irritec®
don't wait for rain™

MICROIRRIGAZIONE EINDOR



866

MICROIRRIGATORE CAPOVOLTO

CODICE	LT/H	PREZZO (€)	CONF.	Ø MT	CAT.
IR.ID866.040	40	1,08	100	6,6	A
IR.ID866.060	60	1,08	100	6,6	A
IR.ID866.070	70	1,08	100	8,0	A
IR.ID866.090	90	1,08	100	8,0	A
IR.ID866.120	120	1,08	100	8,0	A
IR.ID866.160	160	1,08	100	8,6	A



866PC

CAPOVOLTO AUTOCOMPENSANTE

CODICE	LT/H	PREZZO (€)	CONF.	Ø MT	CAT.
IR.ID866A35	35	1,48	100	6,6	A
IR.ID866A70	70	1,48	100	6,6	A
IR.ID866A90	90	1,48	100	6,6	A



10351

INNESTO FEMMINA

CODICE	Ø	PREZZO (€)	CONF.	BOX	CAT.
IR.ID10351	F. x 5 mm.	0,125	100	-	A



10335

INNESTO AD OLIVETTA

CODICE	Ø	PREZZO (€)	CONF.	BOX	CAT.
IR.ID10335	5 x 8 mm	0,125	100	-	A



53000

VALVOLA ANTIGOCCIA

CODICE	APERTURA	PREZZO (€)	CONF.	BOX	CAT.
IR.ID53005	1.0	1,68	100	-	A
IR.ID53010	1.5	1,68	100	-	A



STD52

STAND COMPLETO PREMONTATO

CODICE	Ø	PREZZO (€)	CONF.	BOX	CAT.
IR.IDSTD52	per SXFC	3,60	100	-	A



706

IRRIGATORE A FARFALLA

CODICE	DESCR.	PREZZO (€)	CONF.	BOX	CAT.
IR706.015	60 lt/h - 1,5 mt	0,21	500	1500	A
IR706.020	150 lt/h - 2 mt	0,21	500	1500	A
IR706.025	250 lt/h - 2,5 mt	0,21	500	1500	A
IR706.030	350 lt/h - 3,0 mt	0,21	500	1500	A



700

MICROIRRIGATORE DINAMICO 360°

CODICE	LT/H	PREZZO (€)	CONF.	Ø MT	CAT.
IR.ID700.040	40	0,53	100	3,0	A
IR.ID700.060	60	0,53	100	4,0	A
IR.ID700.070	70	0,53	100	4,4	A
IR.ID700.090	90	0,53	100	4,6	A
IR.ID700.120	120	0,53	100	5,2	A
IR.ID700.160	160	0,53	100	5,4	A



USARE STAND STD52

SXFC

IRRIGATORE MONOGETTO 1/2'' M.

CODICE	LT/H	PREZZO (€)	CONF.	Ø MT	CAT.
IR.IDSX32	350 marrone	11,70	100	17,0	A
IR.IDSX45	500 giallo	11,70	100	20,0	A
IR.IDSX65	750 rosso	11,70	100	21,0	A
IR.IDS10RG	deflettore	1,05	1	-	A



10364

INNESTO MASCHIO

CODICE	Ø	PREZZO (€)	CONF.	BOX	CAT.
IR.ID10364	M. x 5 mm.	0,125	100	-	A



10380

TAPPO CHIUSURA INNESTO FEMMINA

CODICE	Ø	PREZZO (€)	CONF.	BOX	CAT.
IR.ID10380	5 mm	0,090	100	-	A



12096

INNESTO FEMMINA- 3/8''

CODICE	Ø	PREZZO (€)	CONF.	BOX	CAT.
IR.ID12096	F. x 3/8 M.	0,24	100	-	A



ASTA

ASTA METALLO 6 MM 1,2 MT

CODICE	Ø	PREZZO (€)	CONF.	BOX	CAT.
IR.IDAML612	6 mm/1,2 mt	2,70	100	-	A
IR.ID10461	riduz. 6/8 mm	0,13	100	-	A



TCP

TUBO CONTRAPPESO

CODICE	DESCR.	PREZZO (€)	CONF.	BOX	CAT.
IR.TCP100	1 mt	0,63	1	100	A



GOCCIOLATORI TECO



GOCCIOLATORE AD INNESTO 4,5 MM
0 - 6 LT/H - REGOLABILE FINO ALLA CHIUSURA
OPPURE AUTOCOMPENSANTE 4 LT/H

**GOCCIOLATORE
DELTA-DRIP**

CODICE	DESCRIZIONE	PREZZO (€)	CONF.	BOX	CAT.
TC.200916	DeltaDrip innesto regolabile 0-6 lt/h	0,28	100	6500	A
TC.200904	DeltaDrip su astina regolabile 0-6 lt/h	0,72	25	1000	A
TC.202754	DeltaDrip astina 4 lt/h autocompensante	0,75	25	1000	A
TC.202784	DeltaDrip passante su astina 4 lt/h autocompensante	0,82	25	1000	A



GOCCIOLATORE AD INNESTO 4,5 MM
0 - 40 LT/H - REGOLABILE FINO ALLA CHIUSURA
OPPURE AUTOCOMPENSANTE 30 LT/H

**GOCCIOLATORE
OTTIMA**

CODICE	DESCRIZIONE	PREZZO (€)	CONF.	BOX	CAT.
TC.200016	Ottima innesto regolabile	0,30	100	6500	A
TC.200026	Ottima filetto 4 mm regolabile	0,37	100	6500	A
TC.200034	Ottima su astina regolabile	0,66	25	1000	A
TC.204294	Ottima su astina passante regolabile	0,82	25	1000	A
TC.203264	Ottima su astina autocompensante 30 lt/h	1,30	25	1000	A
TC.204334	Ottima su astina passante autocompensante 30 lt/h	1,43	25	1000	A



GOCCIOLATORE MINIRRIGATORE 360° A VORTICE
0-52 LT/H- REGOLABILE FINO ALLA CHIUSURA
Ø DI GITTATA MAX 4 MT

**GOCCIOLATORE MINIRRIGATORE
MAXIMA**

CODICE	DESCRIZIONE	PREZZO (€)	CONF.	BOX	CAT.
TC.200045	Maxima innesto 4,5 mm regolabile	0,60	50	5000	A
TC.200055	Maxima filetto 4 mm minirrigatore 360° regolabile	0,70	50	5000	A
TC.200064	Maxima su astina minirrigatore 360° regolabile	0,97	25	1000	A
TC.204614	Maxima su astina fisso 45 lt/h autocompensante	1,95	25	1000	A



GOCCIOLATORE AD OMBRELLO
0 - 100 LT/H - REGOLABILE FINO ALLA CHIUSURA
Ø DI GITTATA 25 CM

**GOCCIOLATORE
MINI BUBBLA**

CODICE	DESCRIZIONE	PREZZO (€)	CONF.	BOX	CAT.
TC.201176	Mini Bubbla innesto 4,5 mm	0,32	100	6500	A
TC.201186	Mini Bubbla filetto 4 mm	0,39	100	6500	A
TC.201194	Mini Bubbla su astina	0,69	25	1000	A



MINIRRIGATORE 360° FILETTO 4 MM
74 LT/H
Ø DI GITTATA MAX 7 MT

**MINIRRIGATORE
ORBITA**

CODICE	DESCRIZIONE	PREZZO (€)	CONF.	BOX	CAT.
TC.201055	Orbita 4 mm minirrigatore 360°	0,85	50	-	A
TC.201125	Orbita minirrigatore 360° capovolto	1,00	50	-	A
TC.201404	Orbita 4 mm minirrigatore 360° regolabile	1,41	25	-	A

MICROJETS TECO



MICROJET FILETTO 4 MM
0 - 77 LT/H - REGOLABILE FINO ALLA CHIUSURA
RAGGIO DI GITTATA 2,5 MT

**MICROJET REGOLABILE
IDRA**

CODICE	DESCRIZIONE	PREZZO (€)	CONF.	BOX	CAT.
TC.200085	Idra 90° filetto 4 mm microjet regolabile	0,89	50	-	A
TC.200105	Idra 180° filetto 4 mm microjet regolabile	0,89	50	-	A
TC.200125	Idra 360° filetto 4 mm microjet regolabile	0,89	50	-	A



MICROJET REGOLABILE 0-82 LT/H
COMPLETO DI MICROTUBO E INNESTO
ASTA 31 CM ALTEZZA FISSA

**MICROJET REGOLABILE
AQUILAJET**

CODICE	DESCRIZIONE	PREZZO (€)	CONF.	BOX	CAT.
TC.200342	AquilaJet 90° asta 31 cm c/microtubo - raggio 2,5 mt	4,65	10	100	A
TC.200352	AquilaJet 180° asta 31 cm c/microtubo - raggio 2,3 mt	4,65	10	100	A
TC.200362	AquilaJet 360° asta 31 cm c/microtubo - ø 6,8 mt	4,65	10	100	A

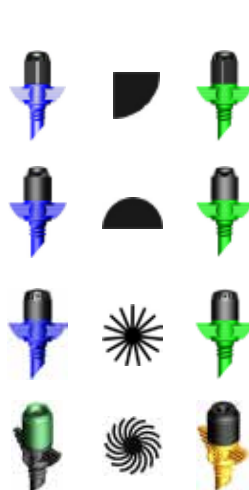

MICROJET TESTA + BASE FILETTO 4 MM
BASE BLU 36 LT/H - RAGGIO GITTATA 2 MT
BASE VERDE 60 LT/H - RAGGIO GITTATA 2,5 MT

**MICROIRRIGATORE
AQUILAJET**

CODICE	DESCRIZIONE	PREZZO (€)	CONF.	BOX	CAT.
TC.200466	Microjet Aquila 90° base blu	0,31	100	-	A
TC.200476	Microjet Aquila 180° base blu	0,31	100	-	A
TC.200486	Microjet Aquila 360° base blu	0,31	100	-	A
TC.200496	Microjet Aquila 90° base verde	0,31	100	-	A
TC.200506	Microjet Aquila 180° base verde	0,31	100	-	A
TC.200516	Microjet Aquila 360° base verde	0,31	100	-	A
TC.020146	Microjet Aquila Mini Vortex	0,31	100	-	A
TC.020502	Microjet Aquila Micro Mist	0,31	100	-	A

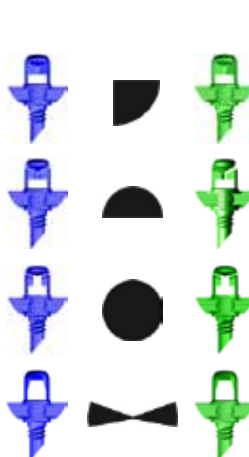

MICROJET FUSIONE UNICA - FILETTO 4 MM
PRECIPITAZIONE BILANCIATA
RAGGIO DI GITTATA MAX 2 MT

**MICROIRRIGATORE
MICROSPRAY**

CODICE	DESCRIZIONE	PREZZO (€)	CONF.	BOX	CAT.
TC.100926	MicroSpray 90° Blue 24 lt/h	0,13	100	-	A
TC.100936	MicroSpray 180° Blue 51 lt/h	0,13	100	-	A
TC.100946	MicroSpray 360° Blue 101 lt/h	0,13	100	-	A
TC.100956	MicroSpray Blue striscia 51 lt/h	0,13	100	-	A
TC.101186	MicroSpray 90° verde 29 lt/h	0,13	100	-	A
TC.101196	MicroSpray 180° verde 60 lt/h	0,13	100	-	A
TC.101206	MicroSpray 360° verde 117 lt/h	0,13	100	-	A
TC.101216	MicroSpray Strip verde 60 lt/h	0,13	100	-	A



ASTA DI SOSTEGNO PER MICROTUBO RIGIDO
+
MICROTUBO RIGIDO PER MINIRRIGATORE

**ASTA ULTRA-STAKE
MICROTUBO RIGIDO**

CODICE	DESCRIZIONE	PREZZO (€)	CONF.	BOX	CAT.
TC.100464	Asta Ultra-Stake 31cm sostegno tubo	0,81	25	-	A
TC.100474	Asta Ultra-Stake 20 cm sostegno tubo	0,62	25	-	A
TC.200816	Tubo rigido 30 cm innesto 4,5 mm	0,42	25	-	A
TC.200826	Tubo rigido 45 cm innesto 4,5 mm	0,58	100	-	A
TC.200846	Tubo rigido 31 cm filetto 4 mm	0,42	100	-	A
TC.200856	Tubo rigido 45 cm filetto 4 mm	0,59	100	-	A



ADATTATORI FILETTATI

CODICE	Ø	PREZZO (€)	CONF.	BOX	CAT.
TC.100696	filetto-innesto	0,087	100	-	A
TC.100716	filetto/filetto	0,087	100	-	A



INNESTO OLIVETTA

CODICE	Ø	PREZZO (€)	CONF.	BOX	CAT.
TC.100706	innesto	0,087	100	-	A



GIUNZIONE MICROTUBO

CODICE	Ø	PREZZO (€)	CONF.	BOX	CAT.
TC.100406	Giunzione	0,087	100	-	A



TEE MICROTUBO

CODICE	Ø	PREZZO (€)	CONF.	BOX	CAT.
TC.100445	Tee	0,150	50	-	A



CROCE MICROTUBO

CODICE	Ø	PREZZO (€)	CONF.	BOX	CAT.
TC.100675	Croce	0,350	50	-	A



GOMITO MICROTUBO

CODICE	Ø	PREZZO (€)	CONF.	BOX	CAT.
TC.100425	Gomito	0,200	50	-	A



FASCETTA FERMATUBO

CODICE	Ø	PREZZO (€)	CONF.	BOX	CAT.
TC.101336	16	0,18	100	-	A
TC.101356	20	0,23	100	-	A



DERIVAZIONE AUTOFORANTE

CODICE	Ø	PREZZO (€)	CONF.	BOX	CAT.
TC.104536	Ø 16 x 4 mm	0,34	100	-	A



ADATTATORE 1/2" F - 4 MM

CODICE	Ø	PREZZO (€)	CONF.	BOX	CAT.
TC.102094	1/2" F - 4 mm	0,56	25	-	A



ADATTATORE 3/4 F. PORTAGOMMA

CODICE	Ø	PREZZO (€)	CONF.	BOX	CAT.
TC.203964	3/4" x 16 mm	1,36	25	-	A
AN.3458	3/4" x 20 mm	1,54	25	-	A
TC.203954	3/4" x 4,5 mm	1,26	25	-	A



CHIAVE FORATURA

CODICE	Ø	PREZZO (€)	CONF.	BOX	CAT.
TC.101934	foro 4 mm	0,71	25	-	A



STICK TAPPINI 4 MM

CODICE	Ø	PREZZO (€)	CONF.	BOX	CAT.
TC.100802	stick 10 pz	0,55	25	-	A



MICROVALVOLE

CODICE	Ø	PREZZO (€)	CONF.	BOX	CAT.
TC.200865	innesto	0,66	25	-	A
TC.200975	4 mm filettata	0,66	25	-	A



FILTRO IN LINEA Ø 16 E 20

CODICE	Ø	PREZZO (€)	CONF.	BOX	CAT.
TC.208284	16x16	3,73	20	-	A
TC.208824	20x20	4,04	20	-	A

MICROALA GOCCIOLANTE 4X6 MM



GOCCIOLATORE 1,5 LT/H - 4X6 MM
IDEALE PER PICCOLE AIUOLE VASI CIRCOLARI
ARBUSTI E GIARDINI VERTICALI

MICROALA GOCCIOLANTE 4X6 MINIDRIP 15 MT

CODICE	DESCRIZIONE	PREZZO (€)	CONF.	BOX	CAT.
IR.MD1515	Micro ala NERA 4 x 6 mm spaziatura 15 cm - 1,5 lt/h	11,90	1	256	A



GOCCIOLATORE 2 LT/H
IDEALE PER PICCOLE AIUOLE VASI CIRCOLARI
ARBUSTI E GIARDINI VERTICALI

MICRO ALA GOCCIOLANTE 30 MT

CODICE	DESCRIZIONE	PREZZO (€)	CONF.	BOX	CAT.
TC.JRM63	Micro ala marrone 4 x 6 mm spaziatura 15 cm - 2 lt/h	29,90	1	10	A

VALVOLE TESTA ROSSA TECO



TR

VALVOLA CON GHIERA GIREVOLE

CODICE	Ø	PREZZO (€)	CONF.	BOX	CAT.
TC.201933	16 x ¾" F.	3,90	20	-	A



TR

VALVOLA DOPPIO PORTAGOMMA

CODICE	Ø	PREZZO (€)	CONF.	BOX	CAT.
TC.206885	16 x 16	1,09	20	-	A
TC.206895	20 x 20	1,10	20	-	A



TR

VALVOLA MASCHIO/TAPE

CODICE	Ø	PREZZO (€)	CONF.	BOX	CAT.
TC.206735	TAPE 16x½"M	1,23	50	-	A
TC.206685	TAPE 16x¾"M	1,26	50	-	A
TC.207155	TAPE 22x½"M	1,33	50	-	A
TC.206985	TAPE 22x¾"M	1,36	50	-	A



TR

VALVOLA MASCHIO/ PORTAGOMMA

CODICE	Ø	PREZZO (€)	CONF.	BOX	CAT.
TC.206905	16 x ½" M.	1,11	50	-	A
TC.206915	16 x ¾" M.	1,13	50	-	A
TC.206925	20 x ½" M.	1,15	50	-	A
TC.206935	20 x ¾" M.	1,22	50	-	A

GOCCIOLATORI ISPEZIONABILI



DPJ

AUTOCOMPENSANTE ISPEZIONABILE

CODICE	LT/H	PREZZO (€)	CONF.	BOX	CAT.
HA.DPJ02	2	0,40	1000	5000	A
HA.DPJ04	4	0,27	1000	5000	A



REGOLABILE CON CHIUSURA

CODICE	LT/H	PREZZO (€)	CONF.	BOX	CAT.
TC.200916	0-6 lt/h	0,28	100	6500	A



TUBO POROSO MONOSTRATO
Ø 20 - 2 LT H/MT

TUBO POROSO Ø 20 NERO

CODICE	DESCR.	PREZZO (€)	CONF.	BOX	CAT.
SUBRAIN	Ø 20	1,60	100 mt	-	A



KIT PER ORTO PRONTO ALL'USO
100 MT ALA GOCCIOLANTE 15 MT TUBO

IRRI-GO ORTO KIT

CODICE	DESCR.	PREZZO (€)	CONF.	BOX	CAT.
IR.IK100	IRRI-GO	61,80	1	-	B



COLONNINA IDRICA TRIANGOLARE DA GIARDINO IN ALLUMINIO VERNICIATO A POLVERI EPOSSIDICHE, COMPLETA DI DUE RUBINETTI E SELLA PORTATUBO IN ACCIAIO INOX.

COLONNINA DA GIARDINO AQUAPOINT

CODICE	DESCRIZIONE	PREZZO (€)	CONF.	BOX	CAT.
CO400	Colonnina 120 cm VERDE SOTTOBOSCO	139,00	1	-	B
CO400T	Colonnina 120 cm TORTORA	139,00	1	-	B
CO400BR	Colonnina 120 cm BRONZO	139,00	1	-	B
CO400B	Colonnina 120 cm BIANCO SABBIA	139,00	1	-	B
CO400V	Colonnina 120 cm VERDE PASTELLO	139,00	1	-	B

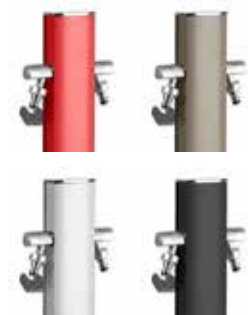

COLONNINA IDRICA OVALE DA GIARDINO IN ALLUMINIO VERNICIATO A POLVERI EPOSSIDICHE, COMPLETA DI DUE RUBINETTI E SELLA PORTATUBO IN ACCIAIO INOX.

COLONNINA DA GIARDINO TOTEM

CODICE	DESCRIZIONE	PREZZO (€)	CONF.	BOX	CAT.
CO407R	Colonnina 120 cm ROSSO CORALLO	149,00	1	-	B
CO407G	Colonnina 120 cm TORTORA	149,00	1	-	B
CO407B	Colonnina 120 cm BIANCO PERLA	149,00	1	-	B
CO407N	Colonnina 120 cm NERO PASTELLO	149,00	1	-	B



COLONNINA IDRICA TONDA DA GIARDINO IN ALLUMINIO VERNICIATO A POLVERI EPOSSIDICHE, COMPLETA DI RUBINETTO COLORATO.

COLONNINA DA GIARDINO LOOP

CODICE	DESCRIZIONE	PREZZO (€)	CONF.	BOX	CAT.
CO409C	Colonnina 120 cm CORTEN	99,00	1	-	B
CO409P	Colonnina 120 cm VERDE	99,00	1	-	B
CO409B	Colonnina 120 cm BIANCO	99,00	1	-	B



CODICE	DESCRIZIONE	PREZZO (€)	CONF.	BOX	CAT.
--------	-------------	------------	-------	-----	------

SISTEMI DI FISSAGGIO

CO134	Zanchette fissaggio 3 pz solo per AQUAPOINT	20,00	1	-	B
CO135	Basamento fissaggio per tutte	35,00	1	-	B

RICAMBI ACCESSORI

CO130	Rubinetto per colonnina a disco ceramico	15,00	1	-	B
CO131	Sella portatubo acciaio per AQUAPOINT/TOTEM	20,00	1	-	B
CO137	Sella portatubo in acciaio per LOOP	15,00	1	-	B
CO262	Pozzetto con valvola d'intercettazione	28,00	1	-	B

ESPOSITORE

CO400TRIO	Espositore metallo 3 pz (1 omaggio ogni 6 pz)	-	1	-	B
-----------	---	---	---	---	---



PER LA GAMMA COMPLETA FARE RIFERIMENTO AL CATALOGO COLORTAP



Long-Life
Metal System



AGGIUNGERE LA "B" PER CODICE BLISTER (ES.C0310B)

ADATTATORE AL RUBINETTO

CODICE	DESCR.	PREZZO (€)	CONF.	€/BL	CAT.
C0310	1/2" F	2,70	25	3,22	B
C0311	3/4" F	2,70	25	3,22	B
C0312	1" F	4,10	25	4,63	B



AGGIUNGERE LA "B" PER CODICE BLISTER (ES.C0330B)

RACCORDO RAPIDO

CODICE	DESCR.	PREZZO (€)	CONF.	€/BL	CAT.
C0330	12/15	7,18	25	7,70	B
C0331	16/19	8,53	25	9,05	B



AGGIUNGERE LA "B" PER CODICE BLISTER (ES.C0340B)

INNESTO RAPIDO PROLUNGA

CODICE	DESCR.	PREZZO (€)	CONF.	€/BL	CAT.
C0340	Niplo	3,07	25	3,59	B



AGGIUNGERE LA "B" PER CODICE BLISTER (ES.C0333B)

ADATTATORE CON RACCORDO RAPIDO

CODICE	DESCR.	PREZZO (€)	CONF.	€/BL	CAT.
C0333	3/4" M	7,90	25	8,42	B
C0334	3/4" F	7,85	25	8,37	B



AGGIUNGERE LA "B" PER CODICE BLISTER (ES.C0611B)

RACCORDO RAPIDO MAXIPASS

CODICE	DESCR.	PREZZO (€)	CONF.	€/BL	CAT.
C0611	3/4" F	4,06	25	4,58	B
C0612	1" F	6,03	25	6,55	B



AGGIUNGERE LA "B" PER CODICE BLISTER (ES.C0760B)

RACCORDO FEMMINA EXPRESS

CODICE	DESCR.	PREZZO (€)	CONF.	€/BL	CAT.
C0760	1/2"	3,17	10	3,80	B
C0761	3/4"	3,17	10	3,80	B
C0762	1"	3,33	10	3,95	B
C0763	1"1/4	4,42	10	5,05	B
C0764	1"1/2	4,68	10	5,30	B



AGGIUNGERE LA "B" PER CODICE BLISTER (ES.C0780B)

PORTAGOMMA EXPRESS

CODICE	DESCR.	PREZZO (€)	CONF.	€/BL	CAT.
C0780	12/14	3,33	10	3,95	B
C0781	15/16	3,43	10	4,05	B
C0782	19/20	3,54	10	4,16	B
C0783	23/25	3,90	10	4,84	B
C0783BIS	20/22	4,06	10	-	B
C0784	30/33	4,73	10	5,36	B
C0784BIS	27/30	5,05	10	-	B
C0785	40/43	6,86	10	7,49	B
C0785BIS	35	7,28	10	-	B



AGGIUNGERE LA "B" PER CODICE BLISTER (ES.C0320B)

ADATTATORE MASCHIO

CODICE	DESCR.	PREZZO (€)	CONF.	€/BL	CAT.
C0320	1/2" M	2,50	25	3,02	B
C0321	3/4" M	2,55	25	3,07	B



AGGIUNGERE LA "B" PER CODICE BLISTER (ES.C0360B)

GIUNTO RIPARATORE

CODICE	DESCR.	PREZZO (€)	CONF.	€/BL	CAT.
C0360	12/15	5,77	25	6,30	B
C0361	16/19	7,54	25	8,06	B



AGGIUNGERE LA "B" PER CODICE BLISTER (ES.C0313B)

RACCORDO GIREVOLE

CODICE	DESCR.	PREZZO (€)	CONF.	€/BL	CAT.
C0313	3/4" F	8,74	25	9,26	B



RACCORDO CON VALVOLA

CODICE	DESCR.	PREZZO (€)	CONF.	€/BL	CAT.
C0337B	12/15 BLISTER	15,03	25	-	B
C0338B	16/19 BLISTER	16,38	25	-	B



AGGIUNGERE LA "B" PER CODICE BLISTER (ES.C0760B)

PORTAGOMMA MAXIPASS

CODICE	DESCR.	PREZZO (€)	CONF.	€/BL	CAT.
C0631	19 mm	10,71	25	11,23	B
C0632	25 mm	11,39	25	11,90	B



AGGIUNGERE LA "B" PER CODICE BLISTER (ES.C0770B)

RACCORDO MASCHIO EXPRESS

CODICE	DESCR.	PREZZO (€)	CONF.	€/BL	CAT.
C0770	1/2"	3,17	10	3,80	B
C0771	3/4"	3,17	10	3,80	B
C0772	1"	3,43	10	3,80	B
C0773	1"1/4	4,42	10	4,05	B
C0774	1"1/2	4,68	10	5,05	B



AGGIUNGERE LA "B" PER CODICE BLISTER (ES.C0755B)

TAPPO EXPRESS

CODICE	DESCR.	PREZZO (€)	CONF.	€/BL	CAT.
C0755	tappo	2,76	10	3,38	B



AGGIUNGERE LA "B" PER CODICE BLISTER (ES.C0740B)

GUARNIZIONE EXPRESS

CODICE	DESCR.	PREZZO (€)	CONF.	€/BL	CAT.
C0740	ricambio	0,62	100	3,07	B

TUBO ESTENSIBILE ROLLY

PER LA GAMMA COMPLETA FARE RIFERIMENTO AL CATALOGO COLORTAP



TUBO ESTENSIBILE COMPLETO DI
LANCIA A PISTOLA

TUBO ESTENSIBILE 7,5 MT

CODICE	DESCR.	PREZZO (€)	CONF.	BOX	CAT.
C05750	7,5 MT	19,60	1	6	B



TUBO ESTENSIBILE COMPLETO DI
LANCIA A PISTOLA

TUBO ESTENSIBILE 15 MT

CODICE	DESCR.	PREZZO (€)	CONF.	BOX	CAT.
C05150	15 MT	30,50	1	6	B



TUBO ESTENSIBILE COMPLETO DI
LANCIA A PISTOLA

TUBO ESTENSIBILE 22,5 MT

CODICE	DESCR.	PREZZO (€)	CONF.	BOX	CAT.
C05225	22,5 MT	43,00	1	6	B



850

LANCIA 40 CM IN METALLO DELUXE
4 FUNZIONI

LANCIA MULTIFUNZIONE 40 CM

CODICE	DESCR.	PREZZO (€)	CONF.	BOX	CAT.
C0850B	innesto	40,56	1	6	B

PISTOLE INNAFFIO



416

NUOVA LEVA IN METALLO
PRESSIONE MASSIMA 6 BAR

PISTOLA COMANDO FRONTALE

CODICE	DESCR.	PREZZO (€)	CONF.	BOX	CAT.
C0416	Sfusa	17,68	1	-	B
C0416B	Blister	18,20	6	48	B



419

PISTOLE DA INNAFFIO IN METALLO
PRESSIONE MASSIMA 6 BAR

7 FUNZIONI COMANDO FRONTALE

CODICE	DESCR.	PREZZO (€)	CONF.	BOX	CAT.
C0419	Sfusa	18,35	1	-	B
C0419B	Blister	18,88	4	32	B



446

PISTOLE DA INNAFFIO IN METALLO
PRESSIONE MASSIMA 6 BAR

PISTOLA DE LUXE SEMPLICE

CODICE	DESCR.	PREZZO (€)	CONF.	BOX	CAT.
C0446	Sfusa	24,86	1	-	B
C0446B	Blister	25,90	8	48	B



449

PISTOLE DA INNAFFIO IN METALLO
PRESSIONE MASSIMA 6 BAR

PISTOLA DE LUXE 3 FUNZIONI

CODICE	DESCR.	PREZZO (€)	CONF.	BOX	CAT.
C0449	Sfusa	24,86	1	-	B
C0449B	Blister	25,90	5	30	B



476

PISTOLE DA INNAFFIO IN METALLO
PRESSIONE MASSIMA 6 BAR

PISTOLA SEMPLICE

CODICE	DESCR.	PREZZO (€)	CONF.	BOX	CAT.
C0476	Sfusa	10,82	1	-	B
C0476B	Blister	11,34	6	48	B



479

PISTOLE DA INNAFFIO IN METALLO
PRESSIONE MASSIMA 6 BAR

PISTOLA 6 FUNZIONI

CODICE	DESCR.	PREZZO (€)	CONF.	BOX	CAT.
C0479	Sfusa	15,39	1	-	B
C0479B	Blister	15,91	4	32	B



436

PISTOLE DA INNAFFIO IN METALLO
PRESSIONE MASSIMA 6 BAR

PISTOLA SEMPLICE

CODICE	DESCR.	PREZZO (€)	CONF.	BOX	CAT.
C0436	Sfusa	15,81	1	-	B
C0436B	Blister	16,33	6	48	B



6012

TUBO SPIRALATO COMPLETO DI
RACCORDI E PISTOLA

KIT TUBO SPIRALATO

CODICE	DESCR.	PREZZO (€)	CONF.	BOX	CAT.
C06012	10 mt	66,20	1	-	B



SOFFIONI IN ALLUMINIO
PER LA GAMMA COMPLETA FARE RIFERIMENTO AL
CATALOGO COLORTAP

**SOFFIONI ALLUMINIO
COLORTAP**



CODICE	DESCRIZIONE	PREZZO (€)	CONF.	BOX	CAT.
C0826	Soffione piatto ø 50 mm attacco 3/4" F 296 fori/ø 0,75 mm	10,40	1	10	B
C0820	Soffione piatto ø 60 mm attacco 3/4" F 469 fori/ø 0,75 mm	9,36	1	10	B
C0830	Soffione bombato ø 60 mm attacco 3/4" F 469 fori/ø 0,75 mm	10,14	1	10	B
C0825	Soffione ø 60 mm attacco 3/4" F 469 fori/ø 0,75 mm	11,50	1	10	B
C0821	Soffione piatto ø 70 mm attacco 3/4" F 631 fori/ø 0,75 mm	10,04	1	10	B
C0831	Soffione bombato ø 70 mm attacco 3/4" F 631 fori/ø 0,75 mm	10,87	1	10	B
C0827	Soffione ø 70 mm attacco 3/4" F 396 fori/ø 0,90 mm	11,23	1	10	B
C0822	Soffione piatto ø 80 mm attacco 3/4" F 919 fori/ø 0,75 mm	11,44	1	10	B
C0832	Soffione bombato ø 80 mm attacco 3/4" F 919 fori/ø 0,75 mm	12,27	1	10	B
C0824	Soffione ø 100 mm attacco 3/4" F 181 fori/ø 1,3 mm	15,40	1	10	B
C0828	Soffione ø 80 mm grandi estensioni attacco 1" F 100 fori/ø 1,3 mm	28,34	1	10	B



PROLUNGHE IN ALLUMINIO
PER LA GAMMA COMPLETA FARE RIFERIMENTO AL
CATALOGO COLORTAP

**PROLUNGHE ALLUMINIO
FILETTATE 3/4" F.**



CODICE	DESCRIZIONE	PREZZO (€)	CONF.	BOX	CAT.
C0806	Prolunga cm 60 attacco 3/4"	20,70	1	10	B
C0809	Prolunga cm 90 attacco 3/4"	24,86	1	10	B
C0812	Prolunga cm 120 attacco 3/4"	29,54	1	10	B
C0474B	Lancia 60 cm con valvola e soffione	43,42	6	.	B
C0420	Valvola a sfera 3/4" maschio femmina	9,05	1	1	B



PROLUNGHE IN ALLUMINIO
PER LA GAMMA COMPLETA FARE RIFERIMENTO AL
CATALOGO COLORTAP

**PROLUNGHE ALLUMINIO
CON LEVA FILETTATE 3/4"**



CODICE	DESCRIZIONE	PREZZO (€)	CONF.	BOX	CAT.
C0856	Prolunga cm. 60 chiusura a leva attacco 3/4"	43,68	1	10	B
C0859	Prolunga cm 90 chiusura a leva attacco 3/4"	47,22	1	10	B
C0852	Prolunga cm 120 chiusura a leva attacco 3/4"	53,20	1	10	B



POZZETTO CON RACCORDO RAPIDO GIREVOLE 360°
VALVOLA A SFERA INTERCAMBIABILE
DIAMETRO 180 MM ALTEZZA 132 MM

POZZETTO CON RUBINETTO



CODICE	DESCRIZIONE	PREZZO (€)	CONF.	BOX	CAT.
C0260	Pozzetto con rubinetto attacco 3/4"	28,00	6	-	B

RUBINETTI DA GIARDINO COLORTAP



455

RUBINETTO CURVO 2 VIE

CODICE	DESCR.	PREZZO (€)	CONF.	BOX	CAT.
C0455	1/2 x 3/4	23,77	10	-	B
C0455B	1/2 x 3/4	24,80	10	-	B



465

RUBINETTO A "Y" 2 USCITE

CODICE	DESCR.	PREZZO (€)	CONF.	BOX	CAT.
C0465B	3/4"	21,90	6	-	B



468

RUBINETTO 3 USCITE

CODICE	DESCR.	PREZZO (€)	CONF.	BOX	CAT.
C0468	3/4"	37,08	5	-	B
C0468B	3/4"	38,12	5	-	B



ADATTATORE AREATORE

CODICE	DESCR.	PREZZO (€)	CONF.	BOX	CAT.
C0103B	F22 x 3/4"	4,89	11	-	B
C0104B	M24 x 3/4"	4,89	10	-	B



464

RUBINETTO CURVO DOPPIO

CODICE	DESCR.	PREZZO (€)	CONF.	BOX	CAT.
C0464	1/2 x 3/4	27,87	10	-	B
C0464B	1/2 x 3/4	28,91	10	-	B



120

RUBINETTO 2 USCITE SILVER

CODICE	DESCR.	PREZZO (€)	CONF.	BOX	CAT.
C0120SB	1/2 "	41,44	10	-	B



469

RUBINETTO 2 USCITE

CODICE	DESCR.	PREZZO (€)	CONF.	BOX	CAT.
C0469	3/4"	25,48	5	-	B
C0469B	3/4"	26,52	5	-	B



AREATORE CON INNESTO

CODICE	DESCR.	PREZZO (€)	CONF.	BOX	CAT.
C0107B	F22	8,11	10	-	B
C0108B	M24	8,11	10	-	B

IRRIGATORI A BATTENTE SETTORIALI



530

PORTATA MAX 16 LT/MIN. - GITTATA MAX. 14 MT - PRESS. MIN 1,5 ATM

IRRIGATORE 1/2"

CODICE	DESCR.	PREZZO (€)	CONF.	BOX	CAT.
C0530	1/2" M	19,50	1	10	B



560

PORTATA MAX 15 LT/MIN. - GITTATA MAX. 14 MT - PRESS. MIN 1,5 ATM

IRRIGATORE SU SLITTA

CODICE	DESCR.	PREZZO (€)	CONF.	BOX	CAT.
C0560	INNESTO	37,80	1	10	B



550

PORTATA MAX 16 LT/MIN. - GITTATA MAX. 14 MT - PRESS. MIN 1,5 ATM

IRRIGATORE SU PICCHETTO

CODICE	DESCR.	PREZZO (€)	CONF.	BOX	CAT.
C0550	INNESTO	22,52	6	20	B



PORTATA 110 LT/H PER 7,5 MT
PORTATA 220 LT/H PER 15 MT

TUBO GOCCIOLATORE

CODICE	DESCR.	PREZZO (€)	CONF.	BOX	CAT.
C03075	7,5 mt	12,45	1	12	B
C03015	15 mt	17,85	1	12	B



3300

PROGRAMMATORE CON
INTERVALLI INFERIORI AL MINUTO

PROGRAMMATORE COLORTAP

CODICE	DESCR.	PREZZO (€)	CONF.	BOX	CAT.
C03300	3/4"	39,70	1	4	B

TUBO DA GIARDINO FITT



TUBO DA GIARDINO MAGLIATO PER UN USO SEMIPROFESSIONALE.
 PRODOTTO CON MATERIE PRIME DI ALTA QUALITÀ ASSICURA ELEVATA
 FLESSIBILITÀ E MALLEABILITÀ.
 STRUTTURA: COPERTURA ESTERNA DI COLORE GIALLO BRILLANTE COPRENTE
 CON BANDA ROSSA, RINFORZO MAGLIATO, STRATO INTERMEDIO DI SOSTEGNO
 BIANCO, STRATO NERO ANTI-ALGA, INTERNO PROTETTIVO BIANCO.



TUBO A 5 STRATI IN PVC ESPANSO

TUBO DA GIARDINO FLORA/FITT

CODICE	DESCR.	PREZZO (€)	CONF.	€/MT	CAT.
TF.F1515	Ø 15 - 15 mt	16,26	1	1,08	B
TF.F1525	Ø 15 - 25 mt	25,58	1	1,01	B
TF.F1550	Ø 15 - 50 mt	51,15	1	1,02	B
TF.F1925	Ø 19 - 25 mt	36,76	1	1,47	B
TF.F1950	Ø 19 - 50 mt	73,53	1	1,47	B
TF.F2525	Ø 25 - 25 mt	62,34	1	2,49	B

CARRELLI ED ACCESSORI AVVOLGITUBO TAMEC



PORTATUBO MURALE ACCIAIO INOX
 COMPLETO DI TASSELLI PER FISSAGGIO

GANCIO MURALE INOX

CODICE	DESCR.	PREZZO (€)	CONF.	C/IVA	CAT.
TA.W10INOX	10 METRI	16,59	1	20,24	C



ACCIAIO VERNICIATO 50M. TUBO DA 1/2"
 APPLICAZIONE A PARETE- STAFFA INCLUSA

AVVOLGITUBO MURALE

CODICE	DESCR.	PREZZO (€)	CONF.	C/IVA	CAT.
TA.WGIM50	50 METRI	80,24	1	97,90	C



PORTATUBO MURALE ACCIAIO INOX
 COMPLETO DI TASSELLI PER FISSAGGIO

AVVOLGITUBO INOX

CODICE	DESCR.	PREZZO (€)	CONF.	C/IVA	CAT.
TA.W50INOX	50 METRI	118,70	1	144,80	C



AVVOLGITUBO REALIZZATO IN ACCIAIO
 VERNICIATO CON POLVERI POLIESTERE

AVVOLGITUBO VERNICIATO

CODICE	DESCR.	PREZZO (€)	CONF.	C/IVA	CAT.
TA.GIM50	50 METRI	83,64	1	102,00	C
TA.GIM100	100 MT	111,30	1	135,80	C



AVVOLGITUBO REALIZZATO IN ACCIAIO INOX
 CAPACITÀ 50 MT TUBO DA 1/2"

AVVOLGITUBO INOX

CODICE	DESCR.	PREZZO (€)	CONF.	C/IVA	CAT.
TA.INOX50	50 METRI	120,60	1	147,20	C



AVVOLGITUBO REALIZZATO IN ACCIAIO
 VERNICIATO CON POLVERI POLIESTERE
 ANCORABILE AL TERRENO

AVVOLGITUBO PROFESSIONALE

CODICE	DESCR.	PREZZO (€)	CONF.	C/IVA	CAT.
TA.QLPG100	100 METRI	151,80	1	185,00	C



AVVOLGITUBO REALIZZATO IN ACCIAIO INOX
 CAPACITÀ 100 MT TUBO DA 1/2"

AVVOLGITUBO INOX

CODICE	DESCR.	PREZZO (€)	CONF.	C/IVA	CAT.
TA.INOX100	100 MT	172,35	1	210,00	C



AVVOLGITUBO DI ESTREMA ROBUSTEZZA
 CAPACITÀ 100M. TUBO DA 1"

AVVOLGITUBO PROFESSIONALE

CODICE	DESCR.	PREZZO (€)	CONF.	C/IVA	CAT.
TA.MARGOT	100 METRI	471,70	1	575,00	C

PER LA GAMMA COMPLETA FARE RIFERIMENTO AL LISTINO SIROFLEX



4430

INNESTO CON CHIUSURA

CODICE	DESCR.	PREZZO (€)	CONF.	BOX	CAT.
SI4330E	¾" F.	3,69	25	barcode	B



4410

INNESTO RAPIDO MASCHIO

CODICE	DESCR.	PREZZO (€)	CONF.	BOX	CAT.
SI4410E	¾"	1,24	25	barcode	B
SI4411E	½"	1,24	25	barcode	B
SI4416	1" grande port.	1,37	25	barcode	B



4400

INNESTO RAPIDO FEMMINA

CODICE	DESCR.	PREZZO (€)	CONF.	BOX	CAT.
SI4400E	¾"	1,08	25	barcode	B
SI4401E	½"	1,08	25	barcode	B
SI4402E	1"	1,28	25	barcode	B
SI4406E	1" grande port.	1,89	25	-	B



4430

INNESTO RAPIDO NIPLEX

CODICE	DESCR.	PREZZO (€)	CONF.	BOX	CAT.
SI4430E	niplex	1,57	25	barcode	B
SI4432	grande portata	1,86	20	-	B



4425

INNESTO RAPIDO STRINGITUBO

CODICE	DESCR.	PREZZO (€)	CONF.	BOX	CAT.
SI4425E	mm 20	2,48	50	barcode	B
SI4426E	mm 26	3,04	25	barcode	B



4450

RACCORDO RAPIDO STRINGITUBO

CODICE	DESCR.	PREZZO (€)	CONF.	BOX	CAT.
SI4450E	mm 20	2,73	50	barcode	B
SI4455E	mm 26	3,27	25	barcode	B
SI4458	26 grande port.	4,07	25	-	B



4480

GIUNTATUBO

CODICE	DESCR.	PREZZO (€)	CONF.	BOX	CAT.
SI4480E	mm 20	2,04	50	barcode	B
SI4481E	mm 26	2,82	25	barcode	B



4550

LANCIA SEMPLICE

CODICE	DESCR.	PREZZO (€)	CONF.	BOX	CAT.
SI4550E	innesto"	2,31	25	barcode	B
SI4546	grande portata	4,11	25	-	B



4600

LANCIA A PISTOLA

CODICE	DESCR.	PREZZO (€)	CONF.	BOX	CAT.
SI4600E	innesto	7,45	10	barcode	B
SI4604	grande portata	7,89	10	-	B



4605

INNAFFIATOIO A PISTOLA

CODICE	DESCR.	PREZZO (€)	CONF.	BOX	CAT.
SI4605E	normale	7,67	10	barcode	B
SI4605/5E	multifunzione	14,18	10	barcode	B



4750

INNAFFIATOIO PROLUNGATO

CODICE	DESCR.	PREZZO (€)	CONF.	BOX	CAT.
SI4750	c/rubinetto	16,32	1	25	B



4755

INNAFFIATOIO CON RUBINETTO

CODICE	DESCR.	PREZZO (€)	CONF.	BOX	CAT.
SI4755E	normale	6,63	20	barcode	B
SI4755/5E	multifunzione	13,18	10	barcode	B

PER LA GAMMA COMPLETA FARE RIFERIMENTO AL LISTINO SIROFLEX



4630

IRRIGATORE 360° SU BASE

CODICE	DESCR.	PREZZO (€)	CONF.	BOX	CAT.
SI4630	fisso 360°	15,99	1	30	B



4640

IRRIGATORE 360° SU BASE

CODICE	DESCR.	PREZZO (€)	CONF.	BOX	CAT.
SI4640	braccio mobile	18,90	1	30	B



4591

IRRIGATORE INTERMITTENZA

CODICE	DESCR.	PREZZO (€)	CONF.	BOX	CAT.
SI4591	1/2" M.	9,38	25	-	B
SI4591/1	3/4" F.	10,04	25	-	B
SI4595	su puntale	12,02	25	-	B



4650

IRRIGATORE A SETTORI

CODICE	DESCR.	PREZZO (€)	CONF.	BOX	CAT.
SI4650	regolabile	24,75	1	30	B



4691

IRRIGATORE OSCILLANTE

CODICE	DESCR.	PREZZO (€)	CONF.	BOX	CAT.
SI4691	15 fori abs	25,58	1	12	B
SI4692	19 fori abs	31,43	1	12	B



4955

GUARNIZIONI

CODICE	DESCR.	PREZZO (€)	CONF.	BOX	CAT.
SI4952	1/2" busta 50 pz	4,79	1	25	B
SI4953	3/4" busta 50 pz	5,34	1	25	B
SI4954	1" busta 25 pz	4,90	1	25	B
SI4955	OR busta 25pz	2,15	1	25	B



4520

DISTRIBUTORE 3 VIE

CODICE	DESCR.	PREZZO (€)	CONF.	BOX	CAT.
SI4520	3/4" F.	18,57	10	80	B



5500

SEMPLICITA' E ROBUSTEZZA
1 PARTENZA AL GIORNO - PILA 9V

PROGRAMMATORE SIROFLEX

CODICE	DESCR.	PREZZO (€)	CONF.	BOX	CAT.
SI5500/S	3/4"	147,00	1	4	B

CANNUCCE ROMPIGETTO BLUE-LINE



SIRIUS

ROMPIGETTO CON SNODO

CODICE	DESCR.	PREZZO (€)	CONF.	BOX	CAT.
SI2505/S	nero/cromato	5,35	30	240	B
SI2505/OS	bianco/cromato	5,35	30	240	B

AREATORE DOCGETTA
22X1M FEMMINA
24X1M MASCHIO



SIRIUS

ROMPIGETTO 11 CM CON SNODO

CODICE	DESCR.	PREZZO (€)	CONF.	BOX	CAT.
SI2507/S	bianco/cromato	8,24	20	160	B

AREATORE DOCGETTA
22X1M FEMMINA
24X1M MASCHIO



SIRIUS

ROMPIGETTO 14 CM SENZA SNODO

CODICE	DESCR.	PREZZO (€)	CONF.	BOX	CAT.
SI2508/S	bianco/cromato	6,30	20	160	B

AREATORE DOCGETTA
22X1M FEMMINA
24X1M MASCHIO



MILADY

ROMPIGETTO FLESSIBILE 13 CM

CODICE	DESCR.	PREZZO (€)	CONF.	BOX	CAT.
SI2515/S	nero/cromato	8,97	100	1200	B

AREATORE DOCGETTA
22X1M FEMMINA
24X1M MASCHIO

BORDURE IN CORTEN



MAT

POSIZIONAMENTO PRATICO E VELOCE, LAMIERE PREDISPOSTE PER GIUNZIONE AD INCASTRO, FORI DI FISSAGGIO CON RIVETTI E/O VITI

mat
lavorazioni metalliche

BORDURA CORTEN 1 MM

CODICE	DESCRIZIONE	PREZZO MT	CONF.
MT.CTH101	Bordura h. 100 mm x 2 mt sp. 1 mm bordo ripiegato	7,00	20 mt
MT.CTH161	Bordura h. 160 mm x 2 mt sp. 1 mm bordo ripiegato	8,00	20 mt
MT.CTH201	Bordura h. 200 mm x 2 mt sp. 1 mm bordo ripiegato	9,50	8 mt
MT.CTH251	Bordura h. 250 mm x 2 mt sp. 1 mm bordo ripiegato	10,50	8 mt

MAT

POSIZIONAMENTO PRATICO E VELOCE, LAMIERE PREDISPOSTE PER GIUNZIONE AD INCASTRO, FORI DI FISSAGGIO CON RIVETTI E/O VITI - CON PICCHETTI

BORDURA CORTEN 1 MM CON PICCHETTI

CODICE	DESCRIZIONE	PREZZO MT	CONF.
MT.CTH101P	Bordura h. 100 mm x 2 mt sp. 1 mm bordo ripiegato	8,50	20 mt
MT.CTH161P	Bordura h. 160 mm x 2 mt sp. 1 mm bordo ripiegato	9,50	20 mt
MT.CTH201P	Bordura h. 200 mm x 2 mt sp. 1 mm bordo ripiegato	11,00	8 mt
MT.CTH251P	Bordura h. 250 mm x 2 mt sp. 1 mm bordo ripiegato	12,00	8 mt

L'ACCESSORIO PICCHETTO DI POSIZIONA AD OGNI METRO PER GARANTIRE MAGGIORE STABILITA'

L'ACCIAIO COR-TEN È UNA LEGA AD ALTE PRESTAZIONI DI RESISTENZA ALLA CORROSIONE, LA CARATTERISTICA DEL COR-TEN È LA FINITURA "RUGGINE" CHE SI MANTIENE INALTERATA PER DECENNI.

LE BORDURE IN COR-TEN SONO FORNITE ALLO STATO GREZZO, L'OSSIDAZIONE INIZIA DOPO L'ESPOSIZIONE DANDO GRADUALMENTE AL PRODOTTO IL CARATTERISTICO COLORE BRUNO.

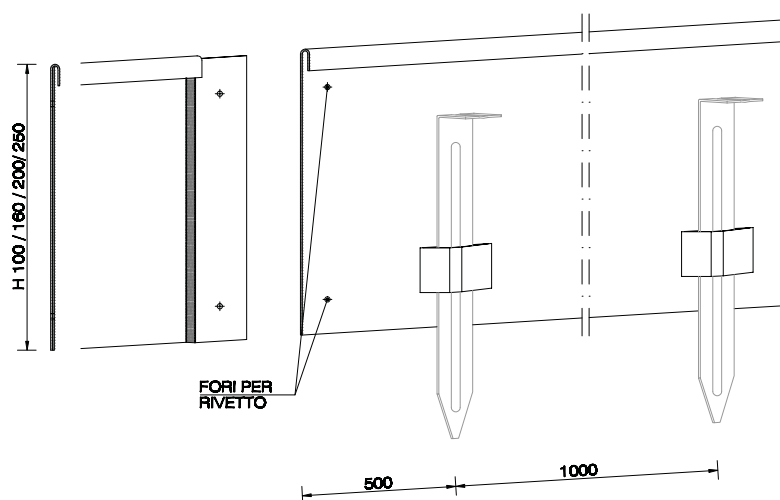

**FIORIERE ED ARREDO GIARDINO IN COR-TEN O VERNICIATI
PREDISPOSIZIONI PER ILLUMINAZIONE A LED
SU RICHIESTA LAVORAZIONI SU MISURA**

mat
lavorazioni metalliche



COLONNINA CON RUBINETTO



COPRIPOZZETTO CON VASCETTA ESTRAIBILE



FIORIERE SALDATE CON O SENZA FONDO
CON RUOTE A SCOMPARSA
BORDI RIPIEGATI INTERNI E/O ESTERNI
PRESISPOSIZIONE PER ILLUMINAZIONE LED
PANNELLI MODULARI COMPONENTI



LUCI DA GIARDINO A LED BASSA TENSIONE

LA LINEA KEY GARDEN, È STATA STUDIATA PER ILLUMINARE TUTTO IL PERIMETRO DELL'ABITAZIONE E DELL'INDUSTRIA IN MODO SEMPLICE, SICURO ED ECONOMICO.



LUCI DA ESTERNO LED

*COLORI DISPONIBILI: BIANCO RAL 9010
MARRONE RAL 8019
GRIGIO RAL 7016*



STICK S DOWN

STICK S UP



VERTICAL

STICK M UP



STELLA

TOWER



TONDA

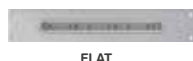

FLAT

CODICE	DESCRIZIONE	IVA INCL.€	ESCLUSA
STIKD	Luce STIK S DOWN H= 404 mm - luce verso il basso	99,00	81,15
STIKU	Luce STIK S UP H= 404 mm - luce verso l'alto-dietro	99,00	81,15
STIKM	Luce STIK M UP. H= 750 mm - luce verso il basso	124,00	101,64
STIKV	Luce VERTICAL H= 246 mm -	94,00	77,05
STIKT	Luce TOWER H= 986 mm	149,00	122,13
ST60	Luce STELLA GRIGIO RAL 7016. H= 600 mm	299,00	245,08
ST100	Luce STELLA GRIGIO RAL 7016. H= 986 mm	349,00	286,07
TN103N	Luce TONDA da incasso	99,00	81,15
STIKF	Luce FLAT H= 240 mm - segnapasso	59,00	48,36

ACCESSORI



CODICE	DESCRIZIONE	IVA INCL.€	ESCLUSA
BOXLED	Centrale controllo 20 luci 24Vdc	299,00	245,08
BOXLEDXL	Centrale XL controllo 64 luci 24Vdc	399,00	325,05
KBOXLED	Garden kit controllo 20 luci 24Vdc	349,00	286,07
KBOXLEDXL	Garden kit XL controllo 64 luci 24Vdc	449,00	368,03
QUADRO	Sensore notte	24,00	19,67
KSTI1	Coppia punte fissaggio su terra	29,00	23,77
SUB44	Trasmettitore SUB 4 tasti BIANCO	39,00	31,97
KSTI2	Coppia scatole incasso FLAT	24,00	19,67
STI3	Contropiastra	9,00	7,38
RX2H	Centrale mini 230Vac per comando a distanza	109,00	89,34
TX2B	Trasmettitore da incasso	49,00	40,16

DO IT YOURSELF TUTTO A PORTATA DI MANO

CENTRALE UNICA
ALIMENTATORE, DIMMER,
CONTROLLO VIA RADIO E VIA
FILO, SENSORE CREPUSCOLARE
E TRASMETTITORE

LED PER ESTERNI
FUNZIONAMENTO
AUTOMATICO A 24V E
CON CONSUMO IN
STAND-BY <0,5W

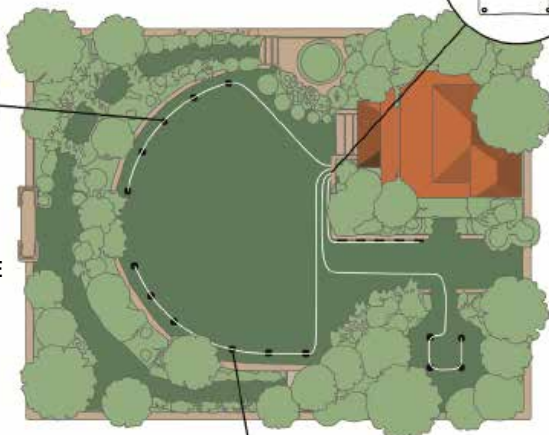

PLUG AND PLAY
COLLEGAMENTI FACILI E SICURI A
24V SENZA SCAVI



KBOXLED

4 USCITE INDIPENDENTI
PER CONTROLLARE 5
LUCI CIASCUNA, PER UN
TOTALE DI 20 LUCI

KBOXLED XL

4 USCITE INDIPENDENTI
PER CONTROLLARE 16
LUCI CIASCUNA, PER UN
TOTALE
DI 64 LUCI*

**TUTTI I CABLAGGI IN BASSISSIMA TENSIONE DI SICUREZZA 24VDC
INTENSITÀ LUMINOSA REGOLABILE TRAMITE RADIOCOMANDO
ACCENSIONE AUTOMATICA LA SERA CON SENSORE CREPUSCOLARE
POSSIBILITÀ DI GESTIRE FINO A 4 ZONE INDIPENDENTI**



COLLEGANDO IL SENSORE NOTTE LE LUCI SI ACCENDERANNO AUTOMATICAMENTE LA SERA E SI SPEGNERANNO AL MATTINO. L'INSTALLAZIONE DEI PUNTI LUCE È SEMPLICE ED INTUITIVA E PUÒ ESSERE ADATTA ANCHE AL FAI DA TE. TRAMITE IL TRASMETTITORE È POSSIBILE CONTROLLARE L'ACCENSIONE E LO SPEGNIMENTO DELLE LUCI VIA RADIO. INOLTRE È POSSIBILE REGOLARE L'INTENSITÀ DELLA LUCE NOTTURNA.

PER EFFETTUARE LA CONNESSIONE BASTA COLLEGARE SOLO DUE FILI A 24V ALLA CENTRALE BOXLED.

IL CONSUMO ENERGETICO È DI 50 MA PER STIK, FLAT E VERTICAL, PER TOWER È DI 100MA E PER STELLA È DI 200MA.



KEY GARDEN

LA SOLUZIONE PER ILLUMINARE
GLI AMBIENTI ESTERNI

SCHEDA SCONTI CLIENTE

CAT.C	• IRRIGAZIONE RAIN BIRD -	8-9		
	• POMPE ED ACCESSORI	28		
	• AVVOLGITUBO TAMEC	53		
CAT.B	• IRRIGAZIONE HUNTER	3-4-5-6-7		
	• ELETTROVALVOLE IRRITEC/RPE	10		
	• SOLEM - BACCARA IRRITROL	11		
	• PROGRAMMATORI ORBIT - K-RAIN	12-13		
	• SISTEMI DI DERIVAZIONE - ACCESSORI	14-15		
	• PUNTI ACQUA POZZETTI COLONNINE	16		
	• TUBO POLIETILENE	19		
	• COLLETTORI OTTONE - VALVOLE A SFERA METALLO	18-23		
	• RACCORDERIA OTTONE IRRIGATORI A BATTENTE TREPPEDI	26-27-29		
	• FORCELLE PER ALA GOCCIOLANTE E TELO	31		
	• IRRI-GO ORTO KIT	47		
	• LINEA COLORTAP AQUAJET	48-49-50-51-52		
	• GREEN LINE SIROFLEX - CANNUCCE ROMPIGETTO	54-55		
	• TUBO DA GIARDINO FITT	53		
CAT.A	• COLLETTORI ELETTROVALVOLE RAIN - PINZA TAGLIATUBO	15		
	• POZZETTI E IDRANTI - COLLETTORI IRRITEC	16-17		
	• PRESE A STAFFA - RACCORDERIA CONNECTO	19-20-21-22		
	• VALVOLE A SFERA PVC - RACCORDERIA FILETTATA	23-24-25		
	• RIDUTTORI DI PRESSIONE ACCESSORI E FILTRI	30-31-32		
	• ALI GOCCIOLANTI E MANICHETTA PIATTA	33-34-35		
	• RACCORDERIA E VALVOLINE PER IRRIGAZIONE A GOCCIA	36-37-38-39-40		
	• SISTEMA GOCCIOLATORI I-DROP - CAPILLARE - MICROTUBI	41-42		
	• MICROIRRIGAZIONE EINDOR	43		
	• MICROIRRIGAZIONE TECO	44-45-46-47		

EarthWay.
GARDEN

SEMINATRICE E COLTIVATORE PER ORTO



PIANTATORI PER ORTO



RACCOGLITORI PER FRUTTA A TERRA

mat.
lavorazioni metalliche

BORDURE E VASCHE SU MISURA IN
CORTEN



ILLUMINAZIONE DA ESTERNI A LED
BASSA TENSIONE



TUBI DA GIARDINO

EarthWay.
EV-N-SPRED

SPARGICONCIME PER PRATO



SEMI E CONCIMI PROFESSIONALI
PER PRATO

EarthWay.
HIGH-OUTPUT

SPARGISALE



IRRORATRICE A BATTERIA
PER TRATTAMENTI



ATTREZZATURE E
INSTALLAZIONE ROBOT RASA EBA



IRRORATRICE A BATTERIA PER TRATTAMENTI



ATTREZZA LA TUA PASSIONE

MUGGIOLI GIARDINAGGIO s.r.l.
Via Visentin, 11
31050 Ponzano Veneto - (Treviso) ITALIA

Tel. +39 0422 969990
fax. +39 0422 967753

info@muggioligiardinaggio.com
www.muggioligiardinaggio.com